

4-22-1980

## An Investigation Into a New England Fisheries Development Project: Towards the Expansion of the Whiting Fishery

J. H. Kaelin  
*University of Rhode Island*

Follow this and additional works at: [https://digitalcommons.uri.edu/ma\\_etds](https://digitalcommons.uri.edu/ma_etds)



Part of the [Aquaculture and Fisheries Commons](#), and the [Oceanography and Atmospheric Sciences and Meteorology Commons](#)

---

### Recommended Citation

Kaelin, J. H., "An Investigation Into a New England Fisheries Development Project: Towards the Expansion of the Whiting Fishery" (1980). *Theses and Major Papers*. Paper 107.  
[https://digitalcommons.uri.edu/ma\\_etds/107](https://digitalcommons.uri.edu/ma_etds/107)

This Major Paper is brought to you by the University of Rhode Island. It has been accepted for inclusion in Theses and Major Papers by an authorized administrator of DigitalCommons@URI. For more information, please contact [digitalcommons-group@uri.edu](mailto:digitalcommons-group@uri.edu). For permission to reuse copyrighted content, contact the author directly.

AN INVESTIGATION INTO A  
NEW ENGLAND FISHERIES DEVELOPMENT PROJECT:

TOWARDS THE EXPANSION OF  
THE WHITING FISHERY

Submitted as partial fulfillment  
of the requirements for the  
Masters of Marine Affairs Degree by:

J. H. Kaelin  
April 22, 1980

TABLE OF CONTENTS

	<u>PAGE</u>
ABSTRACT .....	1(a)
THE PROGRAM .....	1
THE PROJECT .....	12
THE ERC INC. (SEATTLE) TEST .....	22
THE GLOUCESTER (KENNEBEC SEAFOOD) TEST ..	23
THE POINT JUDITH (GLOBAL SEAFOOD) TEST ..	29
ENDNOTES .....	37
APPENDIX A. -- ARENCO-KM WHITE FISH LINE 3500 1A.	
APPENDIX B. -- STATUS OF THE WHITING RESOURCE 1B.	
APPENDIX C. -- HARVESTING CAPABILITIES ....	1C.

ABSTRACT

In 1973, the New England Fishery Development Program (NEFDP), an industry/government partnership, was formed to offset a portion of the economic decline of the New England fishing industry while encouraging the development of underutilized species and nontraditional fishery products.

The purpose of this paper is to examine one of the NEFDP's development projects and to comment on its apparent success.

Since 1977, the Program has been examining the impediments which are delaying full utilization of the whiting resource. It has been determined that the best opportunity for the expansion of that fishery lies in the processing of 18.5 pound defatted whiting fillet blocks for distribution to United States secondary processors.

In 1978 United States producers of fish sticks and portions (secondary processors) showed a record year. The American consumer's demand for these products is increasing annually. Surprisingly, ninety-five percent of the frozen fillet blocks utilized by secondary processors in the U.S. in 1978 were imported. Of these imports, almost 40 million pounds were whiting blocks.

This paper attempts to determine if domestic processors can be expected to produce whiting fillet blocks that can compete in the market place with foreign imports.

Several aspects of the problem are favorably resolved--an abundant whiting resource is available; the domestic fleet has the capability to harvest the resource; a domestic processor has proven his ability to produce a high quality product; a significant demand for the product exists.

The economic efficiency of full-scale commercial production has not been proven, however. Whether or not the

2a.

production of whiting blocks can be a profitable venture for both the processor and the fisherman is still unknown.

THE PROGRAM

In 1970, a group of fishing industry representatives met informally in New Bedford, Massachusetts to discuss the problems facing the New England commercial fishing industry. By that time, the distant water fleets of twenty foreign nations were operating off the New England coast and a 46 percent decline in the quantity of food fish landings between 1963 to 1970 had occurred.<sup>1</sup> (See Figure 1).

Before long, the New England Fisheries Steering Committee (NEFSC) had been formed. The NEFSC, a non-profit educational and trade organization has become a major force in assisting fishermen and the New England fishing industry. Some 65 co-operatives, processors, vessel owners, trade unions and other organizations including the National Marine Fisheries Service (NMFS), make up the Steering Committee's membership today.

On July 1, 1973 the New England Fisheries Development Program (NEFDP) was begun. It was generally felt by the members of the Steering Committee that a significant contribution toward the revitalization of the commercial fishing industry could be achieved if government assisted the industry in the development of underutilized fish species. The industry saw the need to turn to the exploitation of underutilized species because:

1. The availability of traditional fish species such as haddock, cod and yellowtail flounders, had been significantly reduced;
2. A surplus of harvesting and processing capacity and technologies were available to the industry;

Figure 1.

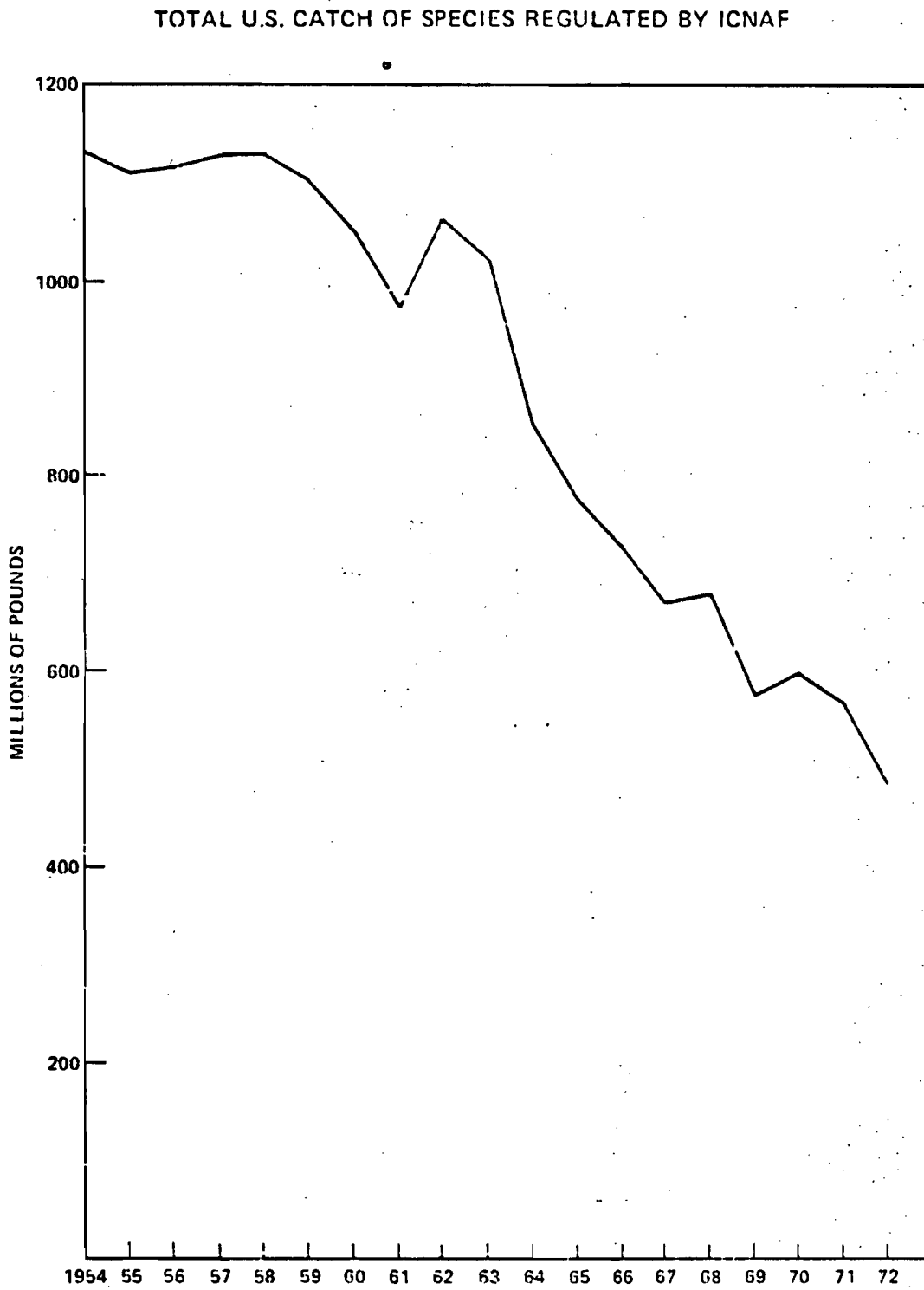

Source: Report to the Congress: Action is Needed Now to Protect Our Fishery Resources, 1976.

3.

3. The industry's limited, traditional fresh fish markets required a product form that was able to compete with the increasing volume of imported frozen fish products.

The NEFDP is an industry-government partnership which was formed through the efforts of the NEFSC and the National Marine Fisheries Service (NMFS) in order to offset some of the economic decline of the New England fishing industry while encouraging the development of underutilized species and non-traditional fishery products. The Program's 1977 Report of Progress outlined the original concept of the NEFDP as involving:

1. A joint industry-government effort governed by broad-based industry involvement and guidance by review and assessment of the Program's direction and goals;
2. The use of existing information from all possible sources -- industry itself, academic institutions, state and federal fisheries organizations (including NMFS and Sea Grant), specialized private companies, foreign sources, etc.
3. An in-depth review of all the nontraditional (under-utilized) species to determine which would be the most promising from the industry's point of view. Included in the review would be such factors as the present and future availability of the resources, its potential marketability, value, industry interest and ability to make use of existing harvesting, holding and processing techniques, etc. to minimize the costs of entering new fisheries.<sup>2</sup>



The direct input from industry in combination with the NMFS on mutually agreed upon objectives provides a useful means of cooperation between government and the industry. The NEFDP was the first attempt at this type of cooperative venture; since its formation, the Pacific Tuna Development Foundation and the Gulf and South Atlantic Fisheries Development Program have been similarly formed through industry-government cooperation.

The NEFDP leadership is provided by a Task Force of six industry advisers from the NEFSC. Also sitting on the Task Force are three State fishery officials (one each from Maine, Massachusetts and Rhode Island) and a NMFS program manager who is appointed to oversee projects and to coordinate NMFS technical support.<sup>3</sup> Contact with other agencies such as Sea Grant, the National Science Foundation, and various universities has also been established.<sup>4</sup>

The function of the Task Force is to jointly design a fisheries development plan for New England. The role of the state and federal government representatives is to provide guidance and counsel, while the industry members are to provide program direction.

The NMFS New England regional director has been placed in charge of all NEFDP projects. The director's responsibility is to coordinate all regional activities and monitor the day-to-day progress of all projects. A national coordinator in Washington monitors the Program's progress and keeps the NMFS Washington staffers informed on its success.

Several NMFS regional units work on the NEFDP under the direction of the regional director. These include the Northeast Fisheries Center, the Atlantic Fisheries Products Technology Center and the Northeast Region Market Research and Services Division.<sup>5</sup>

The jurisdiction of the NEFDP stretches from Maine,

south to Virginia, and west to Minnesota. (See Figure 2). When the program began, two NMFS fisheries development specialists from the Northeast Region's headquarters in Gloucester, Massachusetts administered one project. Today, three projects are administered by three specialists; many development proposals are not being implemented due to a lack of NMFS funds and personnel.

The Fisheries Center gathers and analyzes data on particular fish stocks and produces stock assessments. The Products Technology Center studies and tests processing and product development for species of interest to the Program. Their efforts have included the processing of dogfish and red crab; holding, handling, and processing mixed discarded species; sorting, handling and product development of squid and preparing test food products. The Regional Market Research and Services Division distributes product samples of underutilized species to industry users, exhibits new fishery products at industrial shows and conducts product evaluation studies with food distributors, institutional feeders and grocery chains.

When the NEFDP was instituted, its objective was to expand New England fisheries production by \$10 million per year by the end of 1978 through the sale of processed products of several targeted species. These were:

1. Squid: long-finned (*Loligo*) and short-finned (*Illex*).
2. Offshore crabs: Jonah, rock, with particular emphasis on red crabs.
3. Other shellfish: ocean quahogs, mussels.

Figure 2.

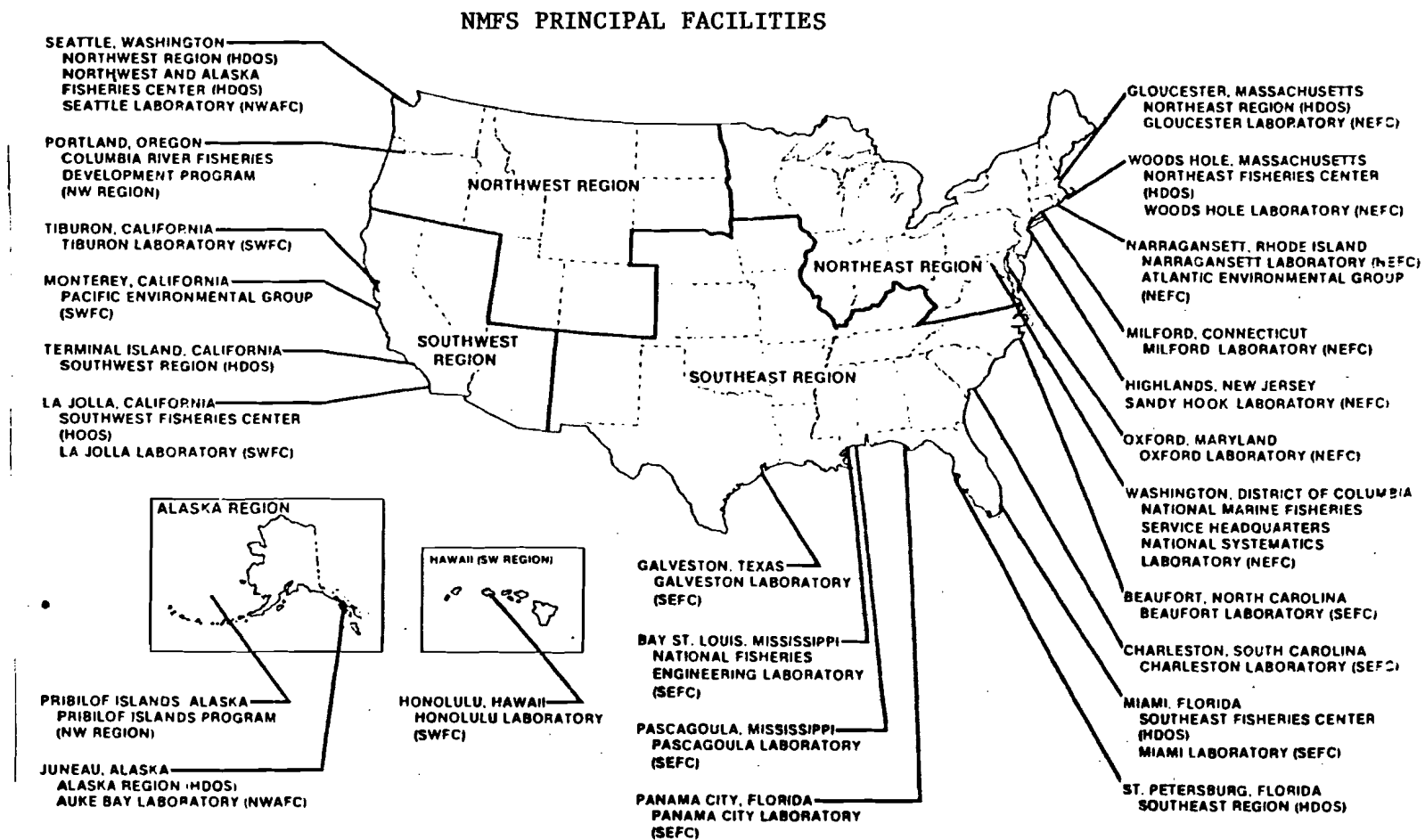

Source: Report of the National Marine Fisheries Service for the Calendar Year 1978

4. Mixed species: composed of former trawl discards and underutilized species such as silver hake (whiting), red hake (ling), ocean pout (yellow eels), skates, dogfish, goosefish and butterfish. Included in this category would be an attempt to develop domestic markets for herring and mackerel.<sup>6</sup>

The 1977 Program report indicates that the original sales goal of \$10 million had been met at that time. The NEFDP has shown the technical and economic feasibility of harvesting and processing most of the nontraditional species listed above. The greatest difficulty that the industry faces, before significant expansion can take place, is the establishment of new domestic and foreign markets for nontraditional fishery products.

Consumer attitudes and tastes are slow to change and have kept domestic demand, for unfamiliar food fish, soft. One objective of the Development Program is to relieve some of the harvesting pressure on the traditionally utilized species such as cod, haddock and flounder, yet these familiar fish are in great demand by the domestic consumer. A strong demand for a product in the market place has a tendency to inflate the product's price. Consequently, the fisherman continues to fish for those traditional species which bring the higher price.

Capturing foreign markets for new domestic fishery products has also proven to be problematic. Product quality has been difficult to maintain due, in part, to the domestic fleet's traditional method of icing fish in pens where the weight of several tons of ice and fish can cause fish to appear damaged even if they have not, in fact, begun to biologically deteriorate.

Also, processing facilities, where products can be prepared for export, are not found in most New England ports. This fact causes delays while fish are transferred from the vessel to trucks and then transported by trucks to plants in New Bedford, Gloucester, or New York. As time passes, from when the fish has been caught until it is processed, quality declines proportionately. Fish must be in excellent condition when they reach the processor if they are to be in top condition when they reach the overseas market. A processing industry adage sums up the problem succinctly: garbage in; garbage out.

Besides producing a quality product for export, processors who are developing markets for nontraditional products often find themselves without sufficient raw material to meet their orders. As was mentioned above, domestic fishermen fish for dollars and, generally, the price paid for nontraditional species is lower than the price for traditional species such as cod, haddock and flounder.

The problems facing the expansion of the industry are not intractable, however. Consumer education and marketing development plans can be initiated to educate the consumer to the economic and nutritional value of fishery products.

Fresher fish can be delivered to the processor if the fisherman takes additional care with his catch. If penned fish are iced heavily, good quality can be maintained for a few days; icing fish in boxes can further preserve freshness although this process is time consuming. Also, slush-ice, a mixture of ice and seawater, or a closed-system refrigerated sea water (RSW) technology can be employed to ensure a higher quality raw product to the processor.

Domestic processors will be able to capture new markets as their capability to sell frozen products increases. Frozen products are less perishable than fresh products and can, therefore, be distributed over a wider area. Further, the majority of fish consumed domestically is in frozen product form. As the amount of frozen production increases, one can expect that prices will begin to smooth out because the processor will be able to retain his product in cold storage while the price is low and to sell it when the market is more favorable.

If frozen products have the ability to smooth out the erratic tendencies of fresh fish prices, the fisherman will stand to gain over the long run. However, a major problem that processors face today, when trying to establish a market for nontraditional fishery products, is a shortage of supply of fish from the fisherman. This is a complicated situation which stems from the pricing structure of the traditional New England fresh-fish market, and the situation has yet to be remedied.

Typically, when the fresh-fish market is glutted (which may occur over-night) prices drop quickly. Also, when the supply of any species of fresh fish becomes scarce, prices can rise rapidly. A processor must figure his cost of raw materials, along with his other production costs, carefully when contracting with customers for x tons of frozen product. When the processor calculates the price that he can pay to the fisherman, it is often lower than what the season's highest fresh-fish price might be, but he is generally willing to buy large quantities of fish at that price, guaranteeing that the price will not change. The processor's price, on the other hand, is usually higher than the season's lowest fresh-fish price and, by offering a constant price for a large volume of fish, the fisherman's profits could be larger over the long term than if

he takes the often-wildly-fluctuating fresh market price by selling to the fresh-fish market.

It is difficult for most fishermen to see things in this light, however. As soon as the captain who has contracted with a processor to sell, for instance, all of the whiting that he can catch for nine cents a pound, sees the fresh-fish price of whiting rise to fifteen cents a pound, he will more than likely sell his trip to the fresh market even though, over the long run, he will probably stand to gain by fishing for a constant price. Meanwhile, the processor who has contracted to deliver x tons of frozen products to his buyer is now without a reliable supply of raw material and the risk of losing a new market becomes obvious.

Another market anomaly further compounds the processor's problems with establishing new outlets for nontraditional fishery products. If the frozen-product processor can induce fishermen to sell to him at a constant price, large volumes of fish will not reach the fresh-fish market. This event can cause the fresh-fish price to rise, due to the supply deficiency, making it even more difficult for the processor to negotiate for an adequate supply of fish to make the new market venture worthwhile.

The fishery development problems outlined above are not new to the NEFDP Task Force. In fact, it is their mission to determine the difficulties that a particular fishery may have in expanding and to try to ameliorate those difficulties.

Since 1977, the NEFDP has been investigating the possibility of developing the whiting fishery. Today, a project is ongoing at Global Seafood in Point Judith, Rhode Island where the feasibility of producing 18.5 pound whiting fillet blocks for distribution to domestic secondary processors is being tested.

11.

The remainder of this paper will describe the process leading to that project and will comment on the project's apparent outcome.



THE PROJECT

Whiting have been an important food fish since the 1920's being sold principally in the south and the midwest. It has been processed into several market forms as butterfly fillets; dressed or headed and gutted (H&G) and the larger "king whiting" sold in fillet form. Whiting has also been used in large amounts for industrial processing into fertilizers, fish meal and animal foods, particularly when a low ex-vessel price does not make careful handling economical.

Consumer demand for butterfly fillets has declined since the early 1960's. Most of the whiting sold today has been processed into frozen H & G packs. Processors begin packing H & G whiting in May of each year and continue through October or November depending on the movement of the stocks. Most of the annual production is sold by the beginning of the Lenten season the following year. Recently, however, lower priced imported packs from South America and South Africa have been effectively competing with the domestically produced product making it difficult for some New England processors to reduce their inventories.<sup>7</sup>

An abundance of whiting appears to be available in the waters off New England. U.S. landings have declined since the early 1960's until 1978 when a slight increase over 1977 was shown. (See Figure 3.) Foreign harvests have been large since 1964 with Russia taking the greatest portion of the catch. Since the implementation of the Fishery Conservation and Management Act (FCMA)<sup>8</sup> in 1977, the foreign catch of whiting has declined until, in 1978, it fell below the domestic harvest. (See Appendix B. and figures 2B., 5B., 8B.)

Figure 3.

U.S. DOMESTIC WHITING HARVEST: DISTANCE CAUGHT OFF U.S. SHORE  
(IN THOUSANDS OF POUNDS AND THOUSANDS OF DOLLARS)

	0 to 3 MILES		3 to 200 MILES		INTERNATIONAL WATERS	
	<u>Pounds</u>	<u>\$</u>	<u>Pounds</u>	<u>\$</u>	<u>Pounds</u>	<u>\$</u>
1978	5,786	896	45,288	6,292	-----	--
1977	3,972	434	41,314	3,785	30	5
1976	5,799	537	41,865	3,436	2	(1)
1975	5,604	679	36,806	3,060	15	1

(1) Less than \$500

SOURCE: FISHERIES OF THE UNITED STATES 1975, 1976, 1977, 1978.

In 1978, United States producers of fish sticks and portions (secondary processors) showed a record year both in quantity produced and in value. (See Figure 4.) Figure 5 indicates an increasing demand for these and other fish products by the American consumer.

Of the frozen fillet blocks used by U.S. secondary processors in the manufacture of fish sticks and portions, more than 99% of the supply was imported during that same year. (See Figure 6.) Of those imports, nearly 40,000,000 pounds represented whiting blocks. (See Figure 7.)

As has been mentioned elsewhere in this paper, one mission of the NEFDP is to conduct in-depth reviews of non-traditional species to determine which species seem to be most promising from the industry's point of view. In 1977, after considering the apparent availability of the whiting resource and the apparent demand for whiting products, the NEFDP Task Force, through the NMFS regional office in Gloucester, contracted with Earl R. Coombs, Inc. (ERC INC.), a group of economic consultants, to determine what impediments existed before full utilization of the whiting resource could be realized by U.S. fishermen. Some of the conclusions of that analysis, entitled Venture Analysis And Feasibility Study Relating to Whiting and Atlantic Mackerel, will be set out below.<sup>9</sup>

The Coombs study suggested that the supply of whiting available to American fishermen was adequate to support a year-round directed fishery and that the demand for whitefish fillets, such as whiting, was firmly established in the United States based upon per capita consumption preferences and population growth.

ERC INC. reported that domestic markets for fresh whiting fillets and for the traditional H & G pack were fully served by domestic and imported products and, therefore, held

Figure 4.

U.S. PRODUCTION OF FISH STICKS  
AND FISH PORTIONS

	Fish Sticks		Fish Portions	
	Thousand lbs.	Thousands \$'s	Thousands lbs.	Thousand \$'s
1969	113,369	51,242	217,071	83,719
1970	115,924	57,722	234,247	87,930
1971	97,777	56,807	240,196	123,136
1972	114,493	61,491	269,204	149,148
1973	*127,156	79,818	298,396	198,984
1974	103,059	64,599	276,226	193,830
1975	91,166	62,182	295,613	216,253
1976	94,169	73,182	344,284	286,240
1977	87,230	68,727	355,443	341,760
1978	93,158	*84,975	*386,611	*412,037

15.

\*Record

SOURCE: Fisheries of the United States 1978.

Figure 5.

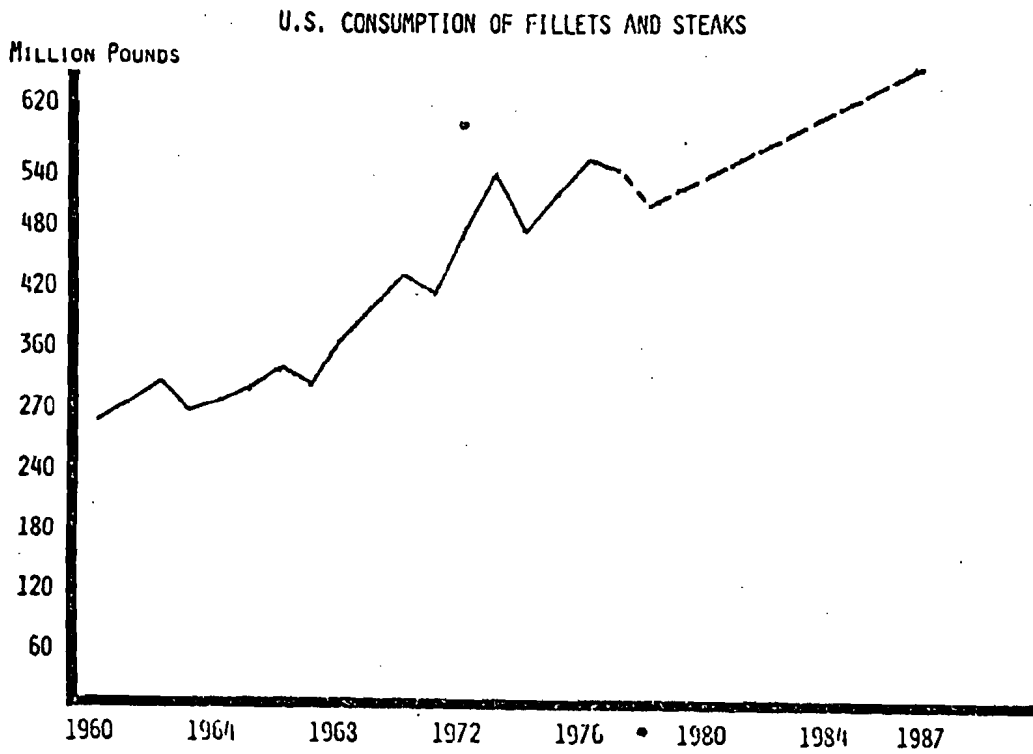
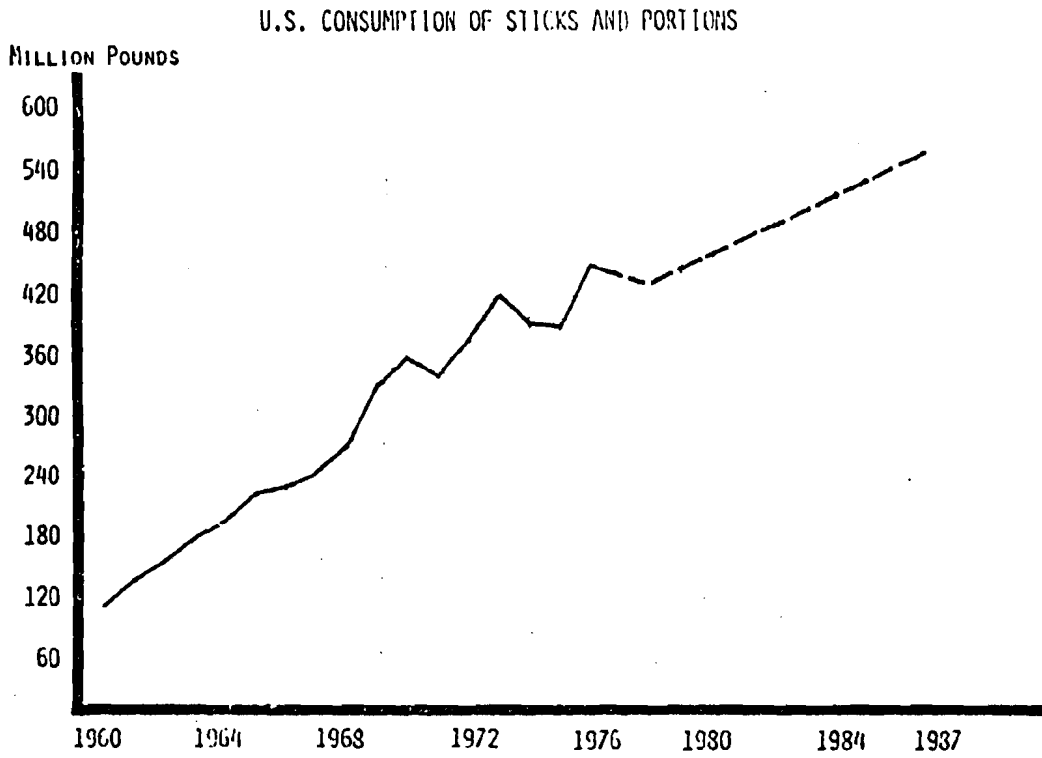

SOURCE: Earl R. Coombs, Inc.  
Export and Domestic Market Study

Figure 6.

U.S. SUPPLY OF FROZEN BLOCKS (ALL SPECIES)  
(Quantity in Edible Weight)

	U.S. PRODUCTION		IMPORTS	
	Quantity (1000 lbs.)	Total Supply to Domestic Processors (%)	Quantity (1000 lbs.)	Total Supply to Domestic Processors (%)
1969	3,497	1.3	266,748	98.7
1970	3,892	1.4	272,655	98.6
1971	6,186	1.9	311,166	98.1
1972	3,508	1.0	355,459	99.0
1973	9,865	2.7	358,730	97.3
1974	4,414	1.6	266,073	98.4
1975	2,357	.7	313,479	99.3
1976	1,697	.4	378,742	99.6
1977	2,138	.6	385,138	99.4
1978	2,135	.5	406,286	99.5

SOURCE: Fisheries of The United States 1978, USDOC.

little promise for expansion. Sighting the large volume of imported whiting fillet blocks that was increasingly being purchased by secondary processors, the study concluded that the production of high quality whiting blocks was the only real prospect for a significant expansion of the domestic whiting fishery.

The Coombs report said:

"Much imported whiting is in frozen fillet block form and is used by secondary processors to convert to fish sticks or battered portions. Imported fillet blocks represent almost 100% of the recent consumption of blocked whiting in the U.S. Over 20 million pounds of frozen whiting blocks were imported in 1976. Projections are for continued growth in the fillet block market. There is no indication that the market is saturated."<sup>10</sup>

The market projections of ERC INC. have been supported by actual occurrence; in 1976 20,570,000 pounds of whiting blocks were imported into the United States but by 1978, imports jumped to nearly 40,000,000 pounds, indicating an increasing demand for the product. (See Figure 7.)

After sighting the potential demand for whiting products, ERC INC. recognized some common problems which are inherent to the industry and which must be addressed before success in marketing a nontraditional fishery product can be realized.

As previously mentioned, a common occurrence in the New England fishery and one which is very apparent in the whiting fishery is the tendency for an abundant supply on the dock to depress

Figure 7.

U.S. IMPORTS OF BLOCKS AND SLABS  
(In Thousands of Pounds and Thousands of Dollars)

	<u>Whiting</u>			<u>Cod</u>			<u>Haddock</u>			<u>Pollock</u>			<u>Minced (All species)</u>		
	Pounds	\$	Avg. Price: \$/Lb.	Pounds	\$	Avg. Price: \$/Lb.	Pounds	\$	Avg. Price: \$/Lb.	Pounds	\$	Avg. Price: \$/Lb.	Pounds	\$	Avg. Price: \$/Lb.
1978	39,817	22,885	.57	204,696	190,971	.93	27,026	26,101	.97	81,294	50,560	.62	19,361	7,684	.40
1977	22,402	11,137	.49	204,872	183,371	.90	30,815	27,023	.88	82,960	41,680	.50	18,617	6,686	.36
1976	20,570	8,288	.40	180,126	117,027	.65	28,547	18,712	.66	95,699	35,315	.37	14,505	4,120	.28
1975	8,727	2,696	.31	160,857	83,963	.52	36,649	19,730	.54	74,831	20,907	.30	9,888	2,072	.21
1974	(1)	(1)	-	113,162	69,714	.62	21,052	13,953	.66	80,052	32,040	.40	(1)	(1)	-

19.

(1) Not Available

SOURCE: Fisheries of the United States 1975, 1976, 1977, 1978.



market prices. This phenomenon has the effect of demotivating the industry as additional effort brings decreased returns.<sup>11</sup>

If fish are frozen and held in storage, prices may become stabilized and fishermen can, therefore, be better assured of an ex-vessel price that will make their efforts worthwhile.

A second part of the equation to smooth out price fluctuations would come from progressive exchanges between buyers and sellers through new marketing techniques and better control of the wholesale supply.<sup>12</sup>

Typically, the New England processor deals in fresh fish products. In New Bedford, the New England city where the greatest volume of fish is landed annually, 90% of the fish sold are fresh while only 10% are frozen.<sup>13</sup> Because of the highly perishable nature of fresh fish products, New England processors are order takers. By expanding into a greater percentage of frozen product production, fish can be held in storage, thereby offering sellers the opportunity to withhold their product while the price is low and to sell it when the market is more reasonable. The net effect of this supply control would be a general stabilization of prices.

Under optimum cold storage conditions of -20 F or below, whitefish products (including whiting), which have a relatively low fat content, can be held for up to four years before consumers who are accustomed to fresh fish find the product distasteful.<sup>14</sup> Fresh fish, on the other hand, deteriorates rapidly after only a few days. With these facts in mind, it becomes obvious that the processor who deals in a frozen product is much less subject to the vagaries of the market place than the fresh-fish processor whose product is rapidly lost to spoilage.

The production of frozen whiting fillet blocks would give the domestic processing industry the opportunity to gain the

market power that is available through frozen products as outlined above.

Coombs' Venture Analysis indicated that in order to supply filleted whiting products at prices within the range of import sales, it would be necessary to use machine processing. A series of complicated calculations were used in the study to show that cutting the fish by hand was not economical due to higher labor costs. This assumption is widely held by the NMFS, the NEFDP and by Global Seafood who is currently under contract to determine if a whiting fillet block can be economically produced by machine cutting. The question that still remains, and is expected to be answered when the data from the Global project is assessed, is whether or not a cost-competitive fillet block can be produced in the U.S., even with the labor-saving advantages of the cutting machines.

Before a processor can be expected to invest in the expensive machinery and facilities needed to produce a new fishery product, such as frozen fillet blocks, he must be assured of a sufficient supply of raw product to base his production on. Production should take place throughout as many months of the year as possible. Traditionally, whiting is landed in New England from May through November.

In 1977, ERC INC. concluded that whiting catches could be increased by the fleets located at that time in the principal whiting ports of Gloucester, Provincetown and Point Judith. The analysis pointed out that the fleet lacked vessels of adequate size and range to fish for whiting in the deep overwintering areas. Processors would need assurances of a supply during as many months as would be possible, therefore, new, larger vessels are needed to fish in winter on the offshore grounds. Within the last three years, several vessels of this type have been built

and are working in the offshore ground fishery. If a stable market for whiting can be established, and a high enough price is paid for the fish, I believe that the harvesting capabilities of the New England fleet is the least problematic area to be considered in the development of the whiting fishery. (See Appendix C.)

Given the apparent demand for high-quality whiting fillet blocks and the apparently abundant resource (see Appendix B.), the most important area of investigation lies in determining if the fish can be processed in the desirable high-quality form at a price that can make the domestic product cost-competitive with imports.

#### THE ERC INC. (SEATTLE) TEST

The first attempt to determine the magnitude of this problem took place in October of 1977 when ERC INC. arranged to process a small quantity (200 pounds) of whiting using commercially available machines which were on display at the Fish Expo in Seattle, Washington.

The tests, run in conjunction with the NMFS, were conducted on machines manufactured by ARENCO Corporation of Gutenberg, Sweden which are designed to process small cod, haddock, pollock and European whiting 10 to 18 inches in length. The machines utilized were:

- (one) ARENCO SFA-4 Filleting and Skinning machine: Processing Rate 60 fish/min.
- (one) ARENCO CIV Heading Machine (which partially eviscerates: Processing Rate 120 fish/min.\*

Whiting used in the test were flown from Gloucester, Massachusetts. The average yield of the fillets was encouraging

\* (See Appendix A. for further information.)

at 29 percent of the round weight of the fish although 20 to 30 percent of the fillets required further hand trimming. These tests were regarded only as an indication that mechanical processing was technically feasible and not that processing whiting fillets by machine would become a commercial reality. Extensive commercial-scale trials would be needed to demonstrate the practical application and economic feasibility of this type of operation.<sup>15</sup>

The NEFDP was encouraged by the prospectus for the expansion of the whiting fishery as outlined by the Coombs Venture Analysis and by the initial success of the machine processing tests held at the Fish Expo. The ARENCO Corporation offered to make available on loan to the NEFDP one SFA-4 filleting and skinning machine and one CIV heading machine to be used for a period of time necessary to evaluate the effectiveness of those machines for processing whiting as a commercial venture.\*

#### THE GLOUCESTER (KENNEBEC SEAFOOD) TEST

It was agreed that a follow-up demonstration would be more meaningful if the machinery was located in a processing plant and operated by plant personnel.

---

\* ARENCO is number two behind BAADER in fish cutting machinery sales in the United States. ARENCO saw an opportunity to establish a toe-hold on the U.S. market by assisting the NEFDP with the Program's whiting project and made their equipment and technicians available free of charge. Reports on the project by NMFS include disclaimers stating that reference to trade names does not imply endorsement by NMFS, NOAA.

Arrangements were made with Kennebec Seafood, a Gloucester processor, to install the machinery and to provide the necessary labor to process an amount of round whiting necessary to produce 5000 pounds of fillet blocks. ARENCO engineers were dispatched from Sweden to assist NMFS personnel, working on the project, in the operation and the adjustment of the machinery.

Slightly more than 30,000 pounds of round whiting were processed during an 11-day period. The labor force varied from four to eight people. One or two workers were required to sort and weigh fish and supply the CIV heading machine. One person operated the CIV machine and one person fed the SFA-4 filleting and skinning machine. Two to three people were required for the inspection and trimming of fillets and one person for block making.<sup>16</sup>

Fish used in the project came from the following sources:

1. Penned fish (iced fish stored in pens in the holds of fishing vessels) held in chilled seawater prior to processing.
2. Boxed fish from day boats.
3. Penned fish iced on board and then boxed.

To demonstrate the importance of fish condition on yield, boxed fish were transferred from the vessel to a chilled seawater (CSW) container at the plant. They were held in CSW overnight and processed the next day. For comparison purposes, 3-day old penned fish were also processed. Most of the fish used during the test were boxed fish, less than one day old, landed in the afternoon and held in refrigeration overnight before processing the next day. The fish held in CSW generally produced the greatest percentage yield of fillet for any day's production. Heavily iced fish also showed high yields. It was evident throughout the test that as the internal temperature of

the fish increased, the yield decreased.

When the fish were taken to the processing area, their internal flesh temperature was taken. The fish were then sorted by size where those smaller than ten inches and those larger than 18 inches were rejected due to the limitations of the machinery. Fish of a suitable size were weighed prior to feeding into the heading machine. Weight of the heads was recorded and headed fish were conveyed to the SFA-4 for filleting and skinning. Napes were also weighed after the filleting operation removed them from the fillet. Careful weighing of the fish processed on a particular run is necessary to determine the effective fillet yield that the machine is producing. Yield is probably the most important aspect of determining the feasibility of a machine cutting operation.

The CIV heading unit was found to have worked flawlessly on fish of the proper size. Problems were encountered, however, when fish larger than 18 inches or fish improperly oriented were run through the machine.

Some experience was necessary for feeding fish to the SFA-4 filleting and skinning machine. Also, fish missing their tails were not able to be processed by the machine because it is that portion of the fish that the machine attaches to during production. If fish were fed too rapidly or oriented improperly, jamming of the machine resulted. It was discovered that soft fish also caused the machine to jam. The amount of hand trimming necessary to remove bones or pieces of skin was also dependent on the condition of the fish. Softer fish required more hand trimming than firmer fish. Generally, if the fish were firm and each successive fish was nearly the same size, the machine was found to have performed well and down time was minimal.

The skinning adjustment was found to be reliable and deep skinned (defatted) fillets could be produced consistently

without frequent adjustment. The average yield for defatted fillets was around 21 percent throughout the production period. Heads were 28 percent; napes 20 percent; skin, bone and viscera 31 percent of the round weight on average.

Blocks were packed using about 18 pounds 14 ounces of fillets in each carton. Upon packing, blocks must be somewhat overpacked due to water loss that occurs during freezing (when the blocks are compressed in plate freezers) and during storage when dehydration naturally takes place. Mr. Earl's Prospectus (See note 16) reported that this amount may have been generous, depending on the time the fillets were allowed to drain before packing. He indicated that, although further tests would be necessary, it appeared that 18 pounds 12 ounces could still yield a consistent net weight of 18.5 pounds after freezing if the blocks were made immediately after inspection and trimming.

The difference between two or three ounces of fillet in an eighteen pound block may, at first, seem insignificant, but such information represents the basis for a processor's decision on the price he can pay a fisherman for his catch, the price that he must get for his finished product, and on the economic feasibility of the entire operation.

The overall quality of the blocks was determined by standard lot inspection procedures in accordance with United States Department of Commerce (USDC) standards throughout the test period. Seafood processors and packers may voluntarily subscribe to a USDC inspection program for fishery products. Users of the service pay for inspection which evaluates the quality of the raw materials, the hygienic preparation of products and certified the final quality and condition of the product. Products packed under continuous USDC inspection can carry Federal inspection marks which certify the wholesomeness and quality of the fishery product. The appearance of the Federal inspection marks have

proven to be very effective in gaining consumer confidence.<sup>17</sup>

All lots of fish inspected by USDC inspectors were of Grade A or high Grade B quality. Flavor and odor were Grade A throughout. Since the test production did not take place under continuous USDC inspection, the finished blocks could not carry the Federal inspection marks, but the inspections which did take place gave the project coordinators a basis for determining the quality of the test's finished product.

USDC inspectors grade a product by using a score sheet. Evaluations of fillet blocks are made on the basis of such considerations as uniformity of size; ragged edges; packaging; air spaces; ice spaces; the appearance of blood spots, bruises and black belly lining; and the occurrence of scales, fin rays and "extraneous material" within the block itself.

Mr. Earl reported that all of the significant defects in the blocks produced in the Gloucester test could be attributed to handling problems caused by insufficient floor space and makeshift arrangements at the Kennebec plant. Mr. Earl explained to me that the fillet block test was set up between the processor's H & G whiting line and his herring processing line making for unnecessary confusion and inefficiencies. Mr. Earl feels that block defects were not related to the inadequacies of the machinery, that most grading defects stemmed from improper filling or underweight blocks, and that point deductions for extraneous material such as fins and scales could have been reduced if the line had been set up properly.

Finished blocks were distributed to major secondary processors in the United States for evaluation. Of the questionnaires distributed to secondary processors by the NMFS Marketing Staff, 78 percent were returned. All but two firms indicated that the overall quality was excellent and that they would purchase domestically produced whiting blocks if they became available. It is



interesting to note that the processors who responded unfavorably to the product have substantial overseas holdings. The most common criticism concerned the small size of the fillets. Generally, northwestern Atlantic whiting are of a smaller size than the southwestern and southeastern Atlantic species which are imported from South America and South Africa respectively.

After the Gloucester test was completed it was determined that the quality of the raw material (round fish) was very important in the overall results of the ARENCO CIV and SFA-4 machinery. High-quality, firm, fish resulted in less jamming of the machinery and provided the highest yield.

The SFA-4 produced smooth fillets without ragged edges or tearing. Frequent adjustments were not necessary when size limits for the fish were monitored. Overall, the machinery was found to have performed well throughout the production run and necessary maintenance was minimal. The only shortcoming of the machine was the yield of the end product.

Close examination of the skeletal structure of whiting shows that whiting has fewer pinbones than the cod or haddock which the ARENCO machines are designed to process. Consequently, it was felt that more of the nape was being removed than was necessary. After the production trials, the machinery was moved to the NMFS Gloucester Technology Laboratory where ARENCO engineers redesigned the nape cutting arrangement. The redesigned parts were manufactured in Sweden, returned to Gloucester, and installed. A few hundred pounds of whiting were processed and the results suggest that the yield was significantly increased.

Before the cutting modification was made, a yield of 27-28 percent was achieved during the short run. This yield figure dropped to 20-21 percent during the production trials.

After modification the yield increased to 33-34 percent during a short run. Although the SFA-4 was not tested in a production situation, with the new cutting arrangement, ARENCO engineers assumed that if another production test was made that a 6-7 percent increase in overall yield could be maintained. This would put the average production yield at around 26-28 percent. As will be seen later in this paper, those engineers' expectations have not been met during the Global Seafood test project.

The Gloucester processing trials showed that adequate technology was available to produce a high quality 18.5 pound defatted whiting fillet block that could be competitive with foreign imports. The trials, however, did not represent an accurate portrayal of a processing operation.

Lack of floor space, unfamiliarity with the equipment, and an inexperienced labor force contributed to inefficiencies that were not overcome in the short period of time represented by the production trial. Mr. Earl noted, in demonstrating the importance of experienced labor, that direct labor costs were reduced 65 percent in a period of 7 working days. The trial also gave much insight into how a fillet block line should function to assure maximum efficiency for fish block production. The economics surrounding a sustained fillet block operation were still untested, however.

#### THE POINT JUDITH (GLOBAL SEAFOOD) TEST

Soon after the end of the Gloucester test, the Fishery Development Services Branch of the NMFS in Gloucester, through its request for proposals (RFP) system, solicited proposals for a joint venture with the NEFDP that would be directed towards the determination of the economic questions surrounding the machine processing of whiting fillets for production as fillet

blocks. Two proposals were received and after evaluation by the NEFDP Task Force, the proposal made by Global Seafood in Point Judith, Rhode Island was accepted.

Global Seafood and the NEFDP subsequently entered into a contract whereby Global would produce 100,000 pounds of defatted whiting fillet blocks to be sold to secondary processors for conversion into sticks and portions. The project is still ongoing with about 40 percent of the contract completed. The finished product has been well received by secondary processors in New England. Gorton's of Gloucester, a major foreign fish importer, has agreed to purchase most of the blocks. The effectiveness of the industry/government partnership of the NEFDP is underlined in this case -- a Gorton's representative is a member of the NEFDP Task Force.

Unfortunately, until the contract is completed, and the NMFS has had an opportunity to evaluate the data, the economic feasibility of the Global contract can not be determined. Currently, Global is selling the whiting blocks to secondary processors at a price that is competitive with the imported products which have traditionally been purchased by those processors. The latest quoted wholesale price for defatted whiting blocks was \$.94 a pound. I have not been able to determine if, by selling whiting blocks at the current market price, the company is realizing a profit or taking a loss.

Foreign whiting block exporting countries such as Africa and South America are hard to compete with in this country. The reason for the foreign producers' competitive edge lies in his direct labor costs. In Africa and South America, whiting are cut by hand while, in the United States, the only way that the manufacture of whiting fillet blocks will be an economical production venture is if the fish can be cut efficiently by machine due to high U.S. labor costs.

There is some doubt about the efficiency of the performance of the ARENCO machines at Global Seafood.<sup>18</sup> The SFA-4 filleting and skinning machine was designed to fillet small cod, haddock, pollock and European whiting. It appears that the machine may not be able to fillet north Atlantic whiting economically. The problem lies in the backbone configuration of the Atlantic whiting. Evidently, the machine's cutting arrangement cannot cut around the fish's backbone without leaving a considerable amount of bone in the fillet. Consequently, only about 20 percent of the fillets, which are being cut by the ARENCO machine, do not need hand inspection or trimming. This fact causes the amount of direct labor needed in the operation to approach uneconomical proportions.

Under normal processing conditions, after the fillet has been cut, it is conveyed to an inspection area where a random sample, usually 20 percent, is hand inspected so that hazardous bones may be removed. Eighty percent of the whiting fillets coming off of the ARENCO machine at Global Seafood require hand inspection and trimming before the fillet is in the necessary condition to be packed as a high quality product. This problem could prove to be crucial to the venture's success.

The yield that is being realized at Global Seafood is currently 20 to 21 percent of the overall round weight of the processed fish. Although ARENCO engineers, after changing the cutting mechanism on the SFA-4 in Gloucester, anticipated production yields to increase to around 26 to 28 percent, this level of efficiency has not been reached.

In a short-term test situation, such as the one in Gloucester that encouraged ARENCO's engineers, each fish can be perfectly oriented into the machine and much care can be taken so that a high yield results. In a production situation, however, the same care is not always taken. Workers may have hangovers,

they may not understand the orienting procedure adequately and it is likely that most never consider yield in the course of a day. Besides high yields, a processor also desires high production volumes. Unfortunately, these two goals are not always compatible, so the efficient processor looks for the attainment of maximum throughput per hour and maximum yield. Simply put, the processor cannot afford to pay his production line workers to exercise the same care that the engineer will use in order to increase fillet yields.

At Global Seafood, where a low average yield of 20 percent is being realized while 80 percent of the fillets produced require hand inspection and trimming, neither a high production volume nor high yields are being realized. Because of this the operation may not prove economically feasible.

Global Seafood has not produced any whiting blocks since February due to the scarcity of whiting in local waters during the winter months. The fish which were being processed then were being brought from the south at high cost because ARENCO engineers were in Point Judith and they needed fish.

Whiting are expected to begin appearing in this area within the next month and production is expected to resume so that the remainder of the contract can be filled. When production begins again, Global Seafoods and the NEFDP will be employing an additional processing method in order to increase the overall yield realized from the whole processed fish.

As was mentioned earlier in this paper, after the fish's head is removed and after the fillet has been cut from the fish's body, the nape, which represents an average of 20 percent of the weight of the whole fish, remains on the carcass. At Global Seafood, the nape will be removed, cleaned and passed through a meat/bone separator and turned into a mince. It is hoped that an additional 10 percent of the overall round weight of the fish

will be retained as a usable product in this way.

The minced flesh will be compressed into a block and sold to secondary processors for conversion into fish sticks, fish cakes, or fish balls. Figure 7 indicates that in 1978, nearly 20 million pounds of minced fish blocks were imported into the United States; the sale of the minced blocks produced by Global Seafood is not anticipated to be a problem.

Given the 20 percent yield that is being produced by the ARENCO filleting machine, the present direct labor, costs of 15 to 18 cents a pound and an additional 10 percent overall yield from the production of minced whiting blocks, the Global Seafood whiting block production process may prove profitable on a production basis. The final determination of this cannot be made at this time, however.

This conclusion does not necessarily apply to the feasibility of finding processors who will invest in the equipment needed to produce whiting blocks. The 1977 Venture Analysis, conducted by ERC INC. for the NEFDP, valued the ARENCO CIV heading machine at \$19,000 and the ARENCO SFA-4 filleting and skinning machine at \$ 39,000 each. (I have been told recently that these costs are very low, although I have been unable to have the current costs quoted to me ). The total investment needed to produce fillet blocks would be greater than the cost of the machines.<sup>19</sup>

Fish processors' profit margins for a pound of finished product is generally around two cents. The Global Seafood project is being carried out on equipment that has been donated by the manufacturer. Whether or not firms would be willing to invest in the production of whiting blocks if their production proves to be economically feasible is a question that remains unanswered.

As has been mentioned earlier in this paper, processors

who are developing markets for nontraditional fishery products are faced with supply uncertainties which increase the risk of initiating a new venture. When the processor agrees to fill an order, he is usually not sure that he can offer a price to fishermen that will be high enough to secure the volume of raw product that he requires for production. Furthermore, when considering the year-around production of a fish that is usually caught only on a seasonal basis, such as whiting, the processor's future becomes even less certain. The only answer that I can find to ameliorate these supply uncertainties is better cooperation between processors and fishermen with the understanding that each holds the future best interests of the other.

The NEFDP has been attempting to develop the whiting industry for nearly three years. Today, the overall success of that venture is still in doubt although many of the impediments to development have been clearly defined, if not removed. Knowing about a problem goes a long way towards solving that problem so it would seem that the Program's development efforts, at least in this case, have been worthwhile. It is still not known, however, whether the whiting fishery can develop to its full potential in the future or whether it already has.

At the very least, this investigation has shown me that one of the greatest impediments that stands in the way of the development of the whiting fishery (or any other fishery) is a lack of coordination and cooperation within the fishing industry.

In 1978, the United States experienced a fishery products trade deficit of over \$2.4 billion dollars. (See Figure 8). In 1976, this deficit was only \$1.5 billion dollars.<sup>20</sup> Meaningful cooperation between the industry and government is evident in the form of the NEFDP. Cooperation is needed between fishermen and processors before any meaningful reduction in the outrageous trade deficit mentioned above can take place.

Figure 8.

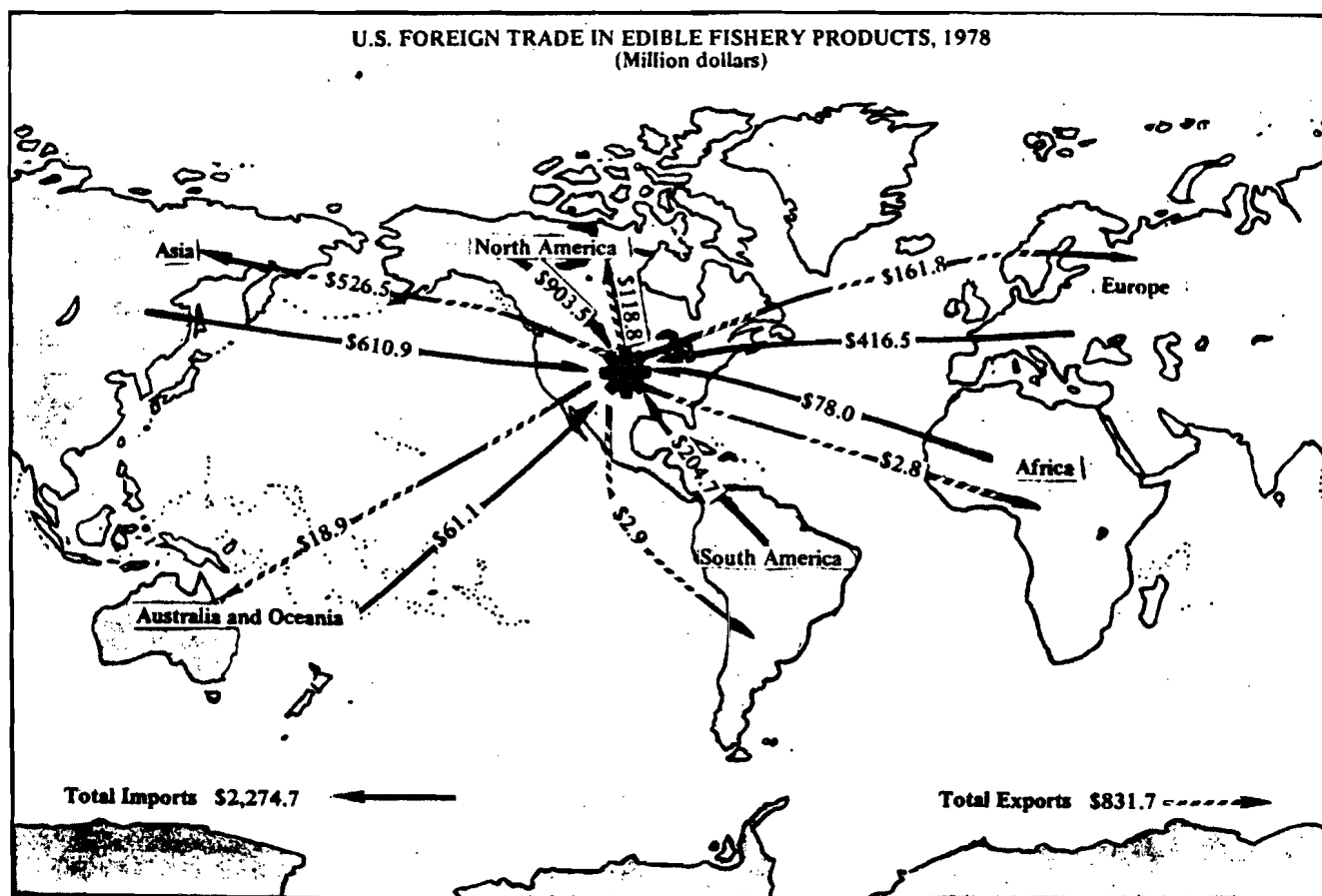

Source: Fisheries of the United States, 1978.



The industry has excellent opportunities to capitalize on an abundant resource, efficient harvesting techniques and modern processing technologies. Unfortunately, the traditionally decentralized and fractionalized fishing industry responds slowly to change and new opportunities. Efforts such as the New England Fisheries Development Program's whiting fishery development project may be providing the necessary catalyst for both co-operation and change.

END NOTES

- <sup>1</sup>Rathjen, W.F., New England Fisheries Development Program, Marine Fisheries Review, Vol. 36, No. 11, November 1974, 23.
- <sup>2</sup>New England Fisheries Development Program: Report of Progress 1977, published by the New England Fisheries Steering Committee, New Bedford, Mass.
- <sup>3</sup>Fisheries Development: Wave of the Future, USDOC, NOAA, NMFS, 10.
- <sup>4</sup>Note 1 supra, at 24.
- <sup>5</sup>U.S. Fishing Industry Can Be Strengthened By Developing Underutilized Fish Resources, DOC, NOAA, NMFS, Report to the Congress by the Comptroller General of the United States, May 30, 1975, 37-45.
- <sup>6</sup>Note 2 supra.
- <sup>7</sup>Earl, P.M., Silver Hake ... A Prospectus, Fisheries Development Services Branch, NMFS, Gloucester, Mass. 1979, Hereinafter cited.
- <sup>8</sup>90 Stat. 331, P.L. 94-265, Act of April 13, 1976.
- <sup>9</sup>Coombs, E.R., Inc., Venture Analysis And Feasibility Study Relating To Whiting And Atlantic Mackerel, for the NEFDP and the NMFS, Northeast Region, Gloucester, Mass., December 1977. Hereinafter referred to as Venture Analysis.
- <sup>10</sup>ibid.
- <sup>11</sup>ibid.
- <sup>12</sup>ibid.
- <sup>13</sup>Personal communication with Brian Veasey of Birds Eye Seafoods, New Bedford, Mass., October 1979.
- <sup>14</sup>Bugess, G.H.O. and C.L. Cutting, eds., Fish Handling and Processing, Chemical Publishing Company, Inc., New York, 1967, 139-181.
- <sup>15</sup>See Venture Analysis, op. cit, note 9 supra, 44-60 for further discussion of the Seattle test.

<sup>16</sup>Most of the discussion of the Gloucester Project is taken from P.M. Earl's Prospectus, op. cit, note 7 supra. Further insights into the test are from a personal communication with Mr. Earl in Gloucester in April of 1980.

<sup>17</sup>Further information on the USDOC's voluntary fishery products inspection program can be found in the Code of Federal Regulations, Title 50: Wildlife and Fisheries, parts 260-279.

<sup>18</sup>The account of the production problems that are being experienced at Global Seafoods are drawn from conversations with David Boocock of Global Seafoods and Paul Earle from the NMFS who is the technical representative for the whiting project. My construction of the current situation may be in error and I extend my apologies to those involved in anticipation of that occurrence..

<sup>19</sup>See Venture Analysis, op. cit. note 9 supra, 49.

<sup>20</sup>Fisheries of the United States 1976, USDOC, NOAA, NMFS, April 1977.

## White Fish Line 3500

Appendix A.

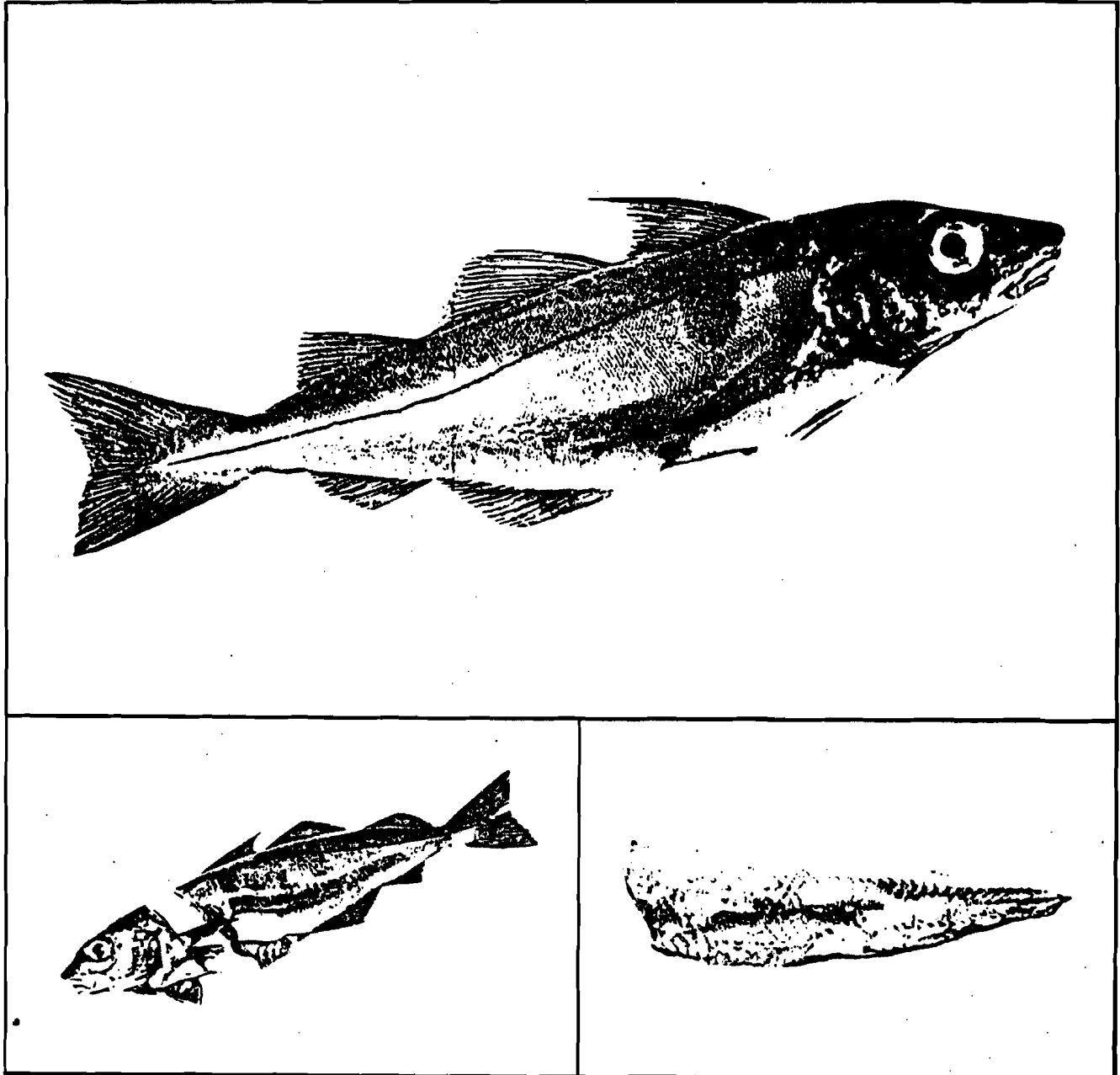

The new Arenco White Fish Line 3500 incorporates the latest experience from production of white fish. Small fishes which have not been processed earlier can now be converted into high quality products. The production line is designed for the processing of small cod, haddock, hake, whiting etc varying from 25 cm (10 in.) up to 38-45 cm (15-18 in.) depending upon the type of fish.

The Arenco White Fish Line 3500 carries out deheading, filleting and skinning. The end products are

- Single fillets with or without skin
- Single fillets without skin and pinbones.
- Block fillets with skin.

The skinning is done without cutting any part of the tail end of the fillet. The fillets are immediately ready for freezing or further processing. Soft types of fish can also be treated in the machines. Every part of the fish flesh can be taken care of. Also belly flaps and backbones can be collected and used for paste production

New features and advantages offered by the Arenco White Fish Line 3500

- Capacity is high - up to 120 fishes per minute
- Gutted or ungutted fish can be processed in the line
- The machines are suitable also for installations on board vessels and sea water can be used in the flushing system
- The machines are silent running which contributes to a silent and pleasant atmosphere in the factory

The Arenco White Fish Line 3500 is built up of one deheading machine CIV or deheading and eviscerating machine CIV/CIF, two filleting and skinning machines SFA-4 and a synchronized transport system. The line offers new and unique possibilities in fish processing. The high capacity and the low number of operators needed also offer very good overall economy in addition to the technical advantages.

### Two kinds of single fillets

The filleting and skinning machine SFA-4 produces two kinds of single fillets:

1. *Single fillets with or without skin* – This is the normal type of fillet sold fresh, frozen, prepared for “the fish and chips market”, etc.
2. *Single fillets without skin and pinbones* – to be used for production of frozen blocks for fish sticks. The belly-flaps and the backbone can be collected separately and all fish flesh on the bones can be taken care of in mincing machines.

Devices for producing block fillets with skin can also be added to the machine.

The filleting and skinning machine handles the fish very gently. Therefore also softer types of fish can be processed.

The skinning is performed by rotating circular knives which can be set to have more or less of the white skin left on the fillet. The skinning is done to the tip of the tail without losing any flesh at all. The yield is then significantly higher than when using the traditional type of skinning machines with a vibrating knife.

Filleting and skinning machine SFA-4 operates in the following way:

The fish is fed manually tail first and is carried that way through the machine. The tail is kept between a wire and the main wheel. At the first station two knives are cutting the fish along the backbone. At the second station the remaining bones including the pinbones are cut away. If skinless fillets are produced the skin is removed in the third station in the machine by two rotating knives. Other parts like bellyflaps, the skin and backbone leave it by separate chutes. The fillets leave the machine on two plastic conveyor bands.

### Production control and safety

In the filleting and skinning machine SFA-4 measuring units for working hours and number of fishes are included for easy production control. Different safety units are installed in the machine as standard. The machine stops, for example, if a fish jams in the machine. Simultaneously the water and air pressure is shut off. The machine also stops if the cover on the reverse side is opened.

### White Fish Line 3500

In order to obtain the highest possible capacity, one de-heading machine CIV or deheading and eviscerating machine CIV/CIF and two filleting and skinning machines SFA-4 can be arranged as a complete production line.

An integrated transport system is delivered together with the machines. This conveyor system begins with an elevator carrying the fish from the machines CIV or CIV/CIF to the raw material conveyor. On the same frame as the raw material conveyor, also other rubber band conveyors for fillets and offal can be built in. An inspection table for easy control of the fillets is included.

An electrical control system regulates the speed of the machines CIV or CIV/CIF which slow down to half speed if one of the filleting and skinning machines SFA-4 cuts out.

The capacity of the different machines in the line is very well matched. The Arenco White Fish Line 3500 is the best alternative for efficient production and good returns from smaller white fish.

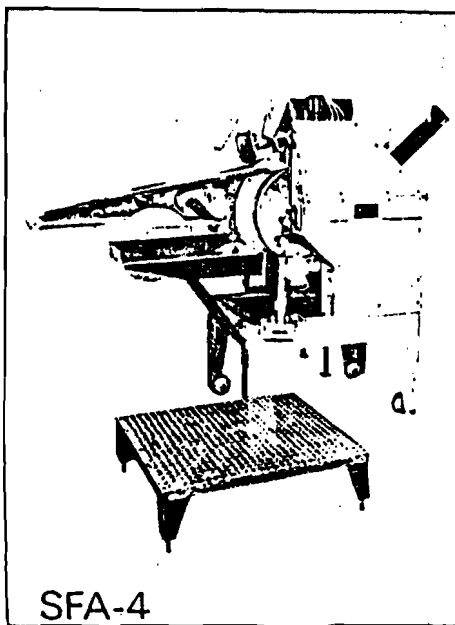

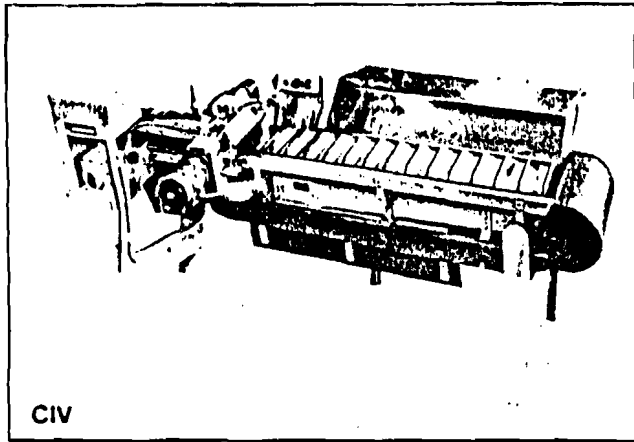

### Deheading machine CIV

Deheading machine CIV is designed for the deheading of small white fish with a length of 25-45 cm (10-18 in.) It has a high capacity - 120 fishes per minute - when fed by two persons. A special head measuring device measures every fish. Because of this unit and the angled cut of the heads, a maximum yield can be obtained.

Deheading machine CIV operates in the following way: The fish is taken from the infeed table of the machine and is fed manually into the fish pockets of the infeed conveyor. The stomach of the fish is placed in the forward direction of the conveyor. The fish passes the head measuring device and the head is thereafter cut away. The fish leaves the machine with the tail end intact.

Deheading machine CIV is delivered as a complete unit with infeed table and is ready for immediate production.

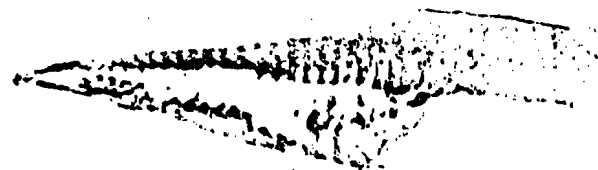
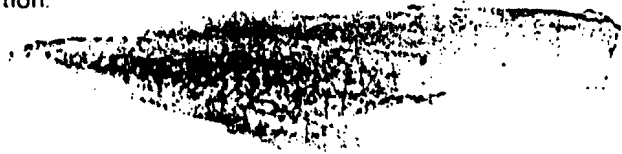

The White Fish Line 3500 produce:

- Single fillets with or without skin.
- Single fillets without skin and pinbones.
- Block fillets with skin

### Gutted or ungutted fish

The fish should be gutted before it is deheaded in the machine CIV. On board a ship the cut can be angled so that the belly with the entrails is cut away altogether.

When running ungutted or round fish in factories ashore the deheading machine CIV is coupled to an eviscerating unit CIF. This unit removes the guts, the black skin and the blood inside the belly.

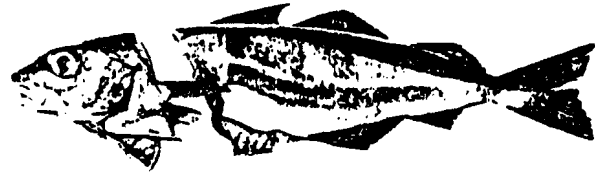

### Filleting and skinning machine SFA-4

The filleting and skinning machine SFA-4 is a machine of a new and unique design. It carries out both the filleting and the skinning. The machine is designed for the processing of small white fish from 25 up to 45 cm (10-18 in.) depending on the type of fish. It works continuously and the capacity is about 50-60 fishes per minute depending on the skill of the operator.

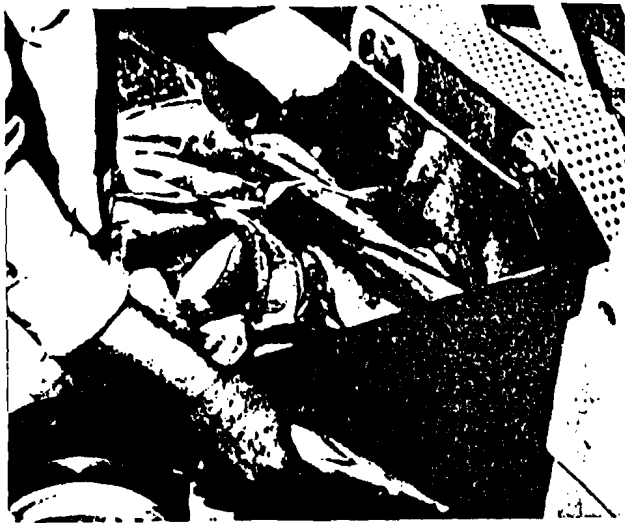

The fish is easily placed tail first on the infed conveyor of the filleting and skinning machine SFA-4. The tail has to be left on fish which will be processed in this machine

#### Maintenance-free materials

All parts of the machines which come into contact with the fish are made of stainless steel, aluminium or plastic. Flushing water keeps the machines clean during operation. The rubber bands on the conveyors are made of special rubber approved for use within the food industry.

#### Sizes and fishes

Fishes of a size from 25 cm (10 in.) up to 45 cm (18 in.) can be processed in the Arenco White Fish Line 3500. The maximum size depends on the thickness of the fish. If it is wide over the head like a cod the maximum length is 38 cm (18 in.). When the fish is lean like pollock the maximum length is approx. 45 cm (18 in.).

Deheading machine CIV

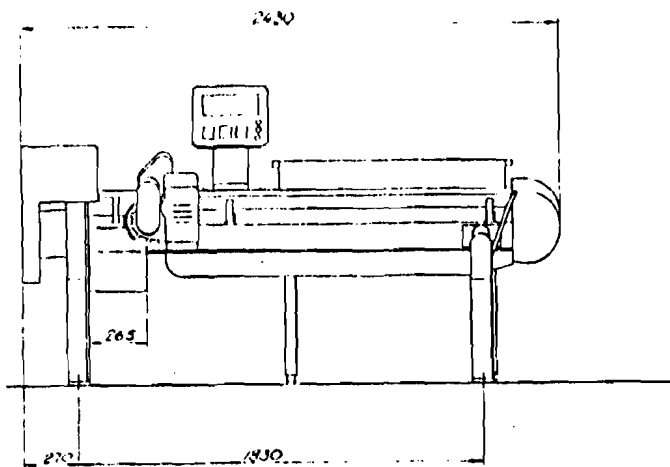

Filleting and skinning machine SFA-4

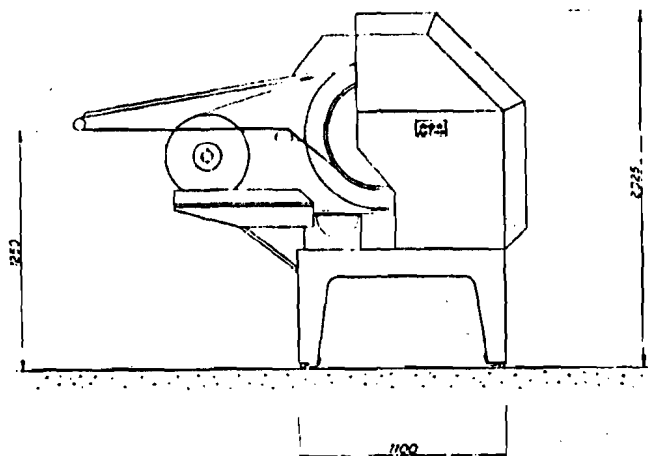

#### Technical data

		CIV	SFA-4
Length	mm (in.)	2.430 (95,7)	2.400 (94,5)
Width	mm (in.)	1.150 (45,3)	1.050 (41,3)
Height, max.	mm (in.)	1.400 (51,2)	2.025 (79,7)
Net weight appr.	kg (lb.)	340 (750)	550 (1.210)
Gross weight appr.	kg (lb.)	600 (1.320)	800 (1.760)
Shipping volume	m <sup>3</sup> (cu.ft.)	6,3 (220)	7,5 (265)
Electrical motor	kW	0,75	1,5
Water: Pressure	kp/cm <sup>2</sup> (p.s.i.)	3 (42,7)	3 (42,7)
Quantity	l/min (Imp. gallons/min)	20 (4,4)	20 (4,4)
Air: Pressure	kp/cm <sup>2</sup> (p.s.i.)	-	7
Quantity	l/min (Imp. gallons/min)	-	100
Operator		2	1
Capacity	fishes/min	120	50-60

# ARENCO-KM

ARENCO AB  
MACHINERY DIVISION OF THE SWEDISH MATCH GROUP

ARENCO AB  
BOX 2041 S-421 02 V. FROLUNDA 2, SWEDEN  
TELEPHONE 04631 45 03 75  
TELEGRAMS FRIEMA  
TELE X 200 08 FRIEMA S

We reserve the right to modifications without notice. All data given refer to fish of average size and normal structure.

## Appendix B. STATUS OF THE WHITING RESOURCE

Silver hake, or whiting, Merluccius bilinearis, is a slender fish, about five to six times as long as it is deep with a large flat-topped head about one-fourth of the total length. Whiting have large eyes and a wide mouth with two or more rows of sharp, curved teeth and a lower jaw that protrudes beyond the upper.

Males range up to 15 inches in length while females get as large as 24 inches and may weigh as much as five pounds. Fish above 2.5 pounds are rare. An average whiting taken commercially in New England would be about 11 to 12 inches long and weigh one half pound.<sup>1</sup>

The silver hake is dark grey but with golden reflections or silvery-iridescent as its name implies. The fish is brightly iridescent when taken from the water, but fades soon after death. Strong swimmers, and extremely voracious, whiting prey on herring and other small schooling fish. Although whiting do not school in definite groups, large numbers of them often swim together and will sometimes drive herring ashore, thereby stranding themselves in pursuit.

Silver hake range from the tideline when coastal waters warm up during late spring and summer and have been trawled as deep as 150 to 400 fathoms on the continental slope off southern New England in winter. Optimal temperature for whiting appear to be from 40°F to 60°F; spawning takes place most successfully in water temperatures of between 50°F and 60°F.

The whiting's geographic range is along the continental shelf of eastern North America northward to the Newfoundland Banks and southward to South Carolina. The fish is most abundant between Cape Sable and New York and the heaviest concentration of spawning occurs from Cape Cod to Gran Manan and on George's Bank between June and September.



Traditionally, whiting has been caught by American fishermen near shore from April through November over all bottom types at depths not less than fifteen fathoms. During the winter months, when whiting migrate offshore to deeper waters, the fish is only an incidental catch in fishing operations concentrating on other species.<sup>2</sup>

### The Availability of the Whiting Resource

Most of the whiting harvested in the United States by United States fishermen is harvested by New England fishermen. In 1960, United States landings peaked at 47,270 metric tons (mt); 1974 catches totaled only 13,635 mt; 1978 landings showed an increasing harvest of 23,181 mt.<sup>3</sup>

During the period 1962-1976, the Atlantic whiting resource was harvested at an average rate of 100,000 mt annually by foreign nations. In 1965, the U.S.S.R. harvested nearly 300,000 mt from the George's Bank area. After the implementation of the Fishery Conservation and Management Act (FCMA)<sup>4</sup> in 1977, foreign fleets were allocated quotas to harvest whiting because stocks were felt to be reasonably plentiful and U.S. harvesting capacity was not expected to take the entire optimum yield (OY).<sup>5</sup> Foreign allocations (TALFF) for 1977, 1978, and 1979 were 73,720 mt; 50,400 mt, and 52,200 mt respectively.<sup>6</sup>

Since 1970, the National Marine Fisheries Service (NMFS) through the National Oceanic and Atmospheric Administration (NOAA) of the Department of Commerce (DOC) has been charged with managing the Nation's marine fisheries. Stock assessments of various species of fish and shellfish are carried out throughout each year by the NMFS Northeast Fisheries Center (NFC) at Woods Hole, Massachusetts.

Two recent reports from the NFC concentrate on the status of the silver hake resource off the northeast coast of the United

States.<sup>7</sup> These reports will be referred to as Anderson (1978) and Anderson and Almeida (1979).

For management purposes, three stocks of whiting are assessed by the Fisheries Center through the fish's geographical range of between Cape Hatteras, N.C. to the Fundian Channel, northeast of George's Bank. These are:

1. The Gulf of Maine stock (ICNAF DIV. 5Y)
2. The George's Bank stock (ICNAF subdiv. 5Ze)
3. The Southern New England-Middle Atlantic stock (ICNAF Subdiv. 5ZW and Stat. Area 6) (See Figure 1B.)

Anderson (1978) explains that some evidence exists that whiting in the area between the Gulf of Maine and Cape Hatteras consist of several discrete stocks. Investigations have shown that few differences exist between fish from the northern part of George's Bank and the inshore areas of the Gulf of Maine nor between fish from the northern George's Bank-Gulf of Maine area and the Southern New England-Middle Atlantic area. Studies using age-length data have shown that the fish in the Gulf of Maine grow faster and attain greater lengths than those in the southern reaches of the fish's range.

Tagging studies conducted in the George's Bank-Gulf of Maine area and off New Jersey in 1957-1963 indicated that little movement of silver hake from one area to another takes place. Survey catches, however, have shown a generally continuous distribution of fish from the southeastern part of George's Bank to the Middle Atlantic area and show no apparent division between a George's Bank stock and a Southern New England-Middle Atlantic stock.

Surveys have enabled NMFS scientists to determine that

Figure 1B.

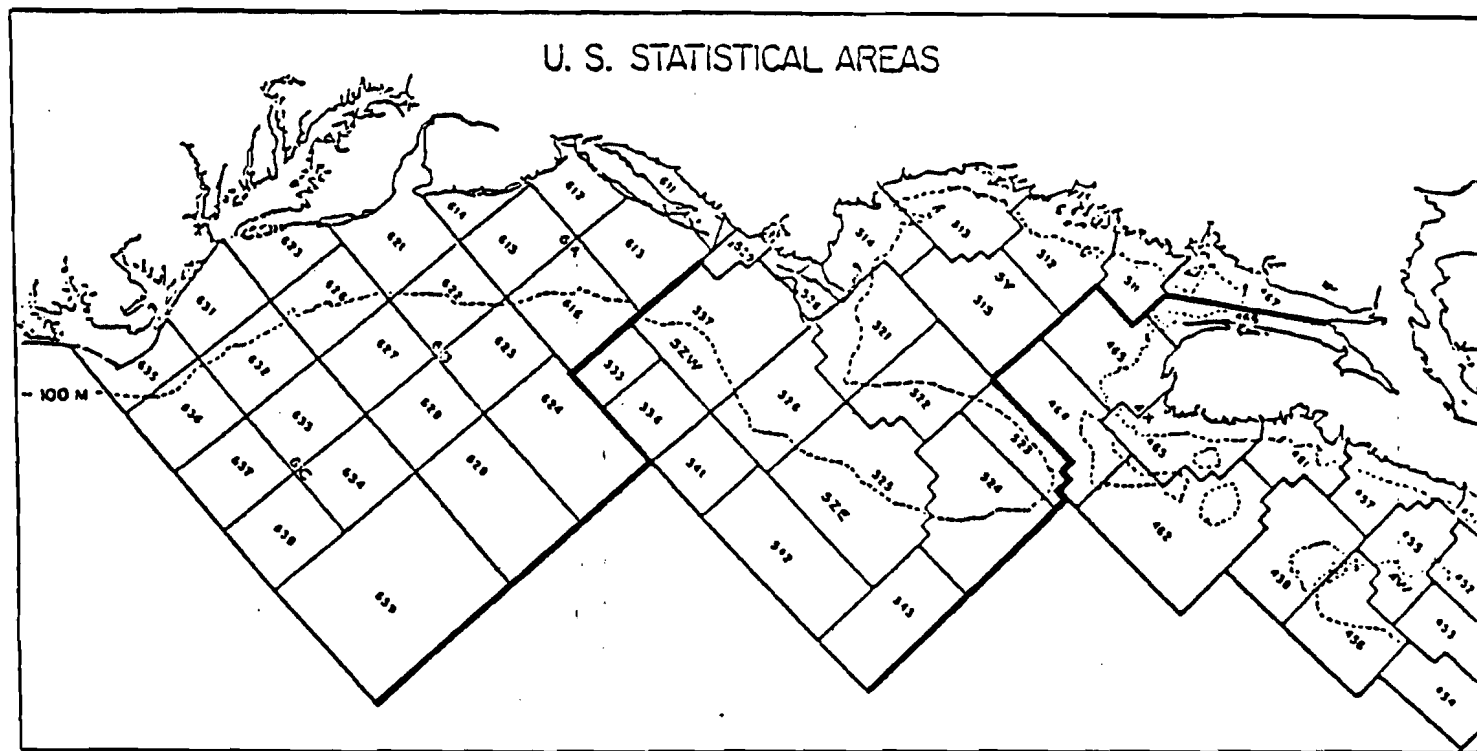

Source: Anderson (1978).

whiting, which summer in the inshore portions of the Gulf of Maine and along the northern part of George's Bank in the warm months of the year, overwinter in deep areas of the Gulf of Maine, and fish which occupy the southern part of George's Bank in the warm months of the year overwinter in deep water along the southern edge of the Bank. Fish in the Southern New England-Middle Atlantic area undergo a seasonal inshore-offshore migration.

Some persons in the fishing industry have claimed that silver hake fished during the summer in the inshore waters of the Gulf of Maine have migrated from southern areas and that, therefore, the whiting stocks should be managed as a unit. Also, available information suggests the possibility of a George's Bank-Gulf of Maine stock and another stock (or two) extending from southern George's Bank to the Middle Atlantic area. The NFC believes, however, that additional studies would be needed to derive conclusions relative to these exceptions. Anderson (1978) writes, that in the meantime, as long as traditional fishing areas and patterns do not substantially change, the present stock delineations are sufficient for management of the resources.

The Northeast Fisheries Center studies utilized United States and foreign commercial catch statistics, U.S. research vessel bottom trawl survey results for 1963-1979, and estimated U.S. recreational catch statistics (for the Southern New England-Middle Atlantic stock only) in the reports on the stocks of the whiting resource. The findings are as reported below.

#### The Gulf of Maine Stock

This fishery has been conducted almost solely by the United States. Limited catches were reported by the U.S.S.R., F.R.G., G.D.R., and Poland in 1964, 1971-1975 and 1977 which averaged less than 10 percent of the total catch in each of those years. (See Figure 2B.)

Total catch during 1955-1964 ranged between 21,500 and

Figure 2B.

## SILVER HAKE CATCH STATISTICS FROM THE GULF OF MAINE STOCK

Year	Catch (tons)						Total	USA catch/day (tons)	International effort as USA days fished
	Bulgaria	FRG	GDR	Poland	USSR	USA			
1955	-	-	-	-	-	33,833	33,833	-	-
1956	-	-	-	-	-	21,448	21,448	15.29	1,403
1957	-	-	-	-	-	36,980	36,980	31.72	1,166
1958	-	-	-	-	-	35,522	35,522	22.20	1,600
1959	-	-	-	-	-	34,750	34,750	22.63	1,536
1960	-	-	-	-	-	23,628	23,628	18.99	1,244
1961	-	-	-	-	-	26,576	26,576	23.02	1,154
1962	-	-	-	-	-	26,253	26,253	20.30	1,293
1963	-	-	-	-	3,660	22,978	26,638	16.50	1,614
1964	-	-	-	-	-	31,722	31,722	22.86	1,388
1965	-	-	-	-	-	22,649	22,649	24.28	933
1966	-	-	-	-	-	21,495	21,495	18.19	1,182
1967	-	-	-	-	-	14,653	14,653	17.11	856
1968	-	-	-	-	-	24,706	24,706	17.83	1,386
1969	-	-	-	-	-	14,632	14,632	10.05	1,456
1970	-	-	-	-	-	11,384	11,384	7.66	1,486
1971	-	-	-	-	53	8,263	8,316	8.55	973
1972	-	131	93	-	857	5,570	6,651	7.14	932
1973	3	29	34	-	483	8,347	8,896	9.87	901
1974	-	-	-	-	578	4,635	5,213	6.28	830
1975	-	11	-	243	845	8,042	9,141	7.84	1,166
1976	-	-	-	-	-	9,760	9,760	16.71	584
1977	-	-	-	-	2	8,728	8,730	15.90	549
1978	-	-	-	-	-	6,220	6,220	7.61	817

Source: Almeida and Anderson, 1979.

37,000 tons and averaged 29,800 tons annually. Catches declined from 31,722 tons in 1964 to 11,384 tons in 1970. During 1965-1970, the annual average catch was 18,300 tons. Whiting catches continued to fall, averaging only 7,900 tons during 1971-1978 while ranging between 5,213 tons in 1974 and 6,220 tons in 1978.

Total allowable catch (TAC) for this stock was set by ICNAF at 10,000 tons for 1973-1974, 15,000 tons for 1978, 10,000 tons for 1976 and 9,000 tons for 1977. Catches were unregulated in 1978-1979.

In the Gulf of Maine, most U.S. catches have traditionally been taken during May through December by small vessels fishing one-day trips in inshore waters, although catches have been made in all months since 1970. Before 1964, the most productive grounds were located in statistical area 514, (See Figure 1B.) which includes Stellwagen Bank, and local ground adjacent to Gloucester and Cape Cod Bay. During 1964-1973, statistical area 513 including the area from Jeffreys Ledge to Casco Bay provided the most abundant catches. During 1974-1977, area 514 again was the most productive area. In 1977, 80 percent of the Div. 5Y whiting catch came from area 514, and 10 percent from each of areas 513 and 515. In earlier years catches were reported from area 512 to be as high as 750 tons in 1969, but have decreased to only a few tons per year in the last five years. In the past several years, the inshore fishery has generally begun in April instead of May, and during 1976-1978, significant catches have been taken from area 515 (deep over-wintering area) during January through April.

Anderson and Almeida (1978) report that the total stock biomass (ages 1 and older) decreased from 219,400 tons in 1955 to a low of only 23,000 tons in 1971 (See Figure 3B.) and then increased to 101,200 tons in 1977. Recruitment to this stock was very poor during the mid and late 1960's (See Figure 4B.) but has improved in the 1970's. The 1974 and 1976 year classes were

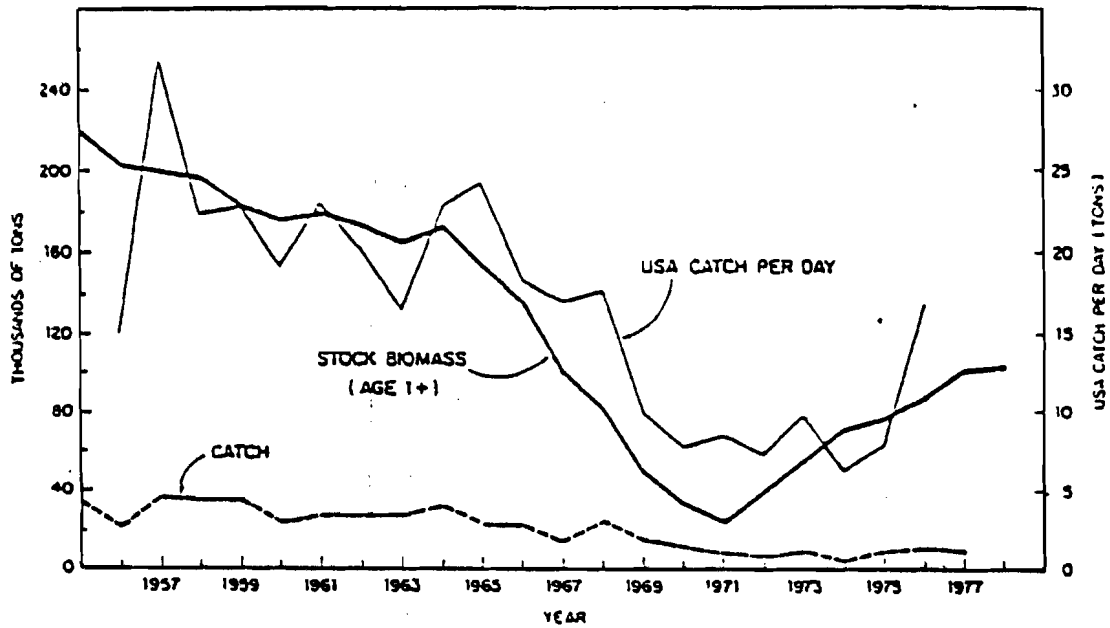

Figure 3B. International catch, stock biomass (ages 1 and older) from virtual population analysis, and USA commercial catch per day from the Gulf of Maine silver hake stock.

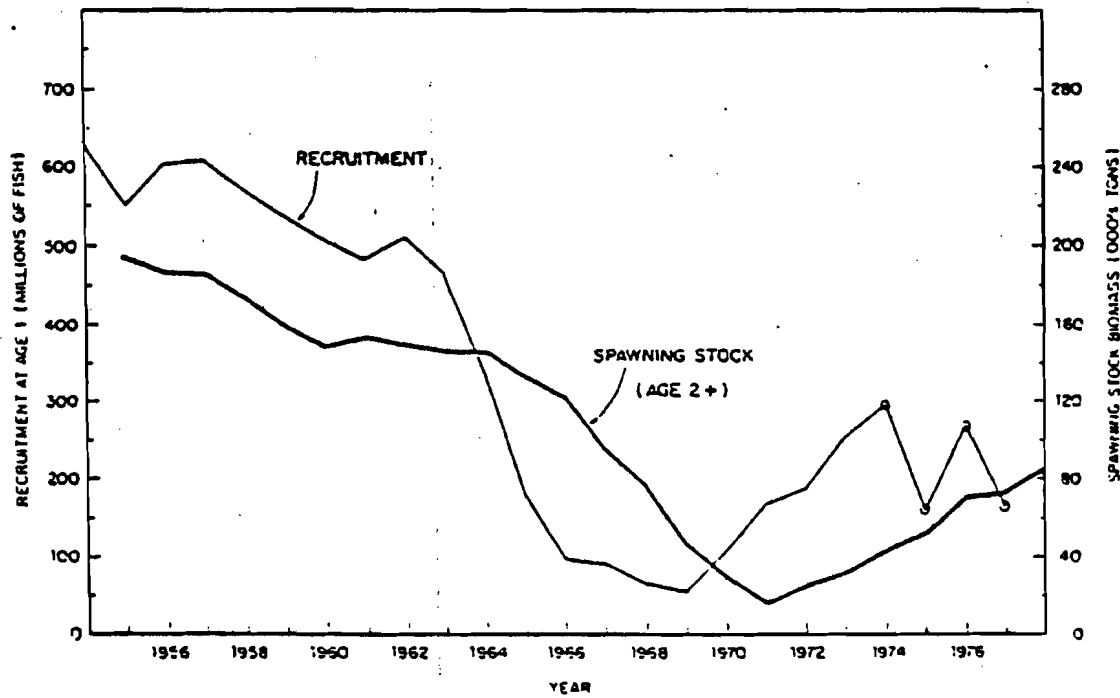

Figure 4B. Gulf of Maine silver hake spawning stock biomass (ages 2 and older) in 1955-1978 and abundance at age 1 of the 1954-1977 year classes. Open circles indicate estimated year-class sizes.

Source: Anderson and Almeida (1978)

estimated to be the strongest observed since 1964 although they were still less than the 1954-1973 mean size.

The scientist's projections indicate that the total stock biomass available at the beginning of 1978 was approximately the same as in 1977, but spawning stock biomass (ages 2 and older) increased more than 15 percent from 1977 to 1978. It was estimated that a catch of about 9,000 tons in 1978 would have maintained the 1979 spawning stock biomass at the 1978 level. Since the 1978 whiting catch was only 6220 tons in the Gulf of Maine, it can be expected that the stock's spawning biomass is in good condition. Future catches around 9,000 tons would allow for the continued rebuilding of the Gulf of Maine stocks.

#### The George's Bank Stock

From the period 1955-1960, the fishery was conducted solely by the United States. In 1960, the Soviet distant water fleets began to operate on George's Bank, harvesting consistently more than the U.S. fleets until 1977. In 1965 the U.S.S.R. fleet caught more than 28 times the volume harvested by American fishermen. From 1967 to 1977, the distant water fleets of Bulgaria, Canada, Cuba, FRG, GDR, Japan, Poland and Romania joined Russia on George's Bank although each of these nation's fleets individually harvested less whiting annually than did the U.S. fleet. (See Figure 5B.)

Total catch increased from an average of 19,000 tons during 1955-1961 to nearly 239,000 tons in 1965 followed by a precipitous decline to 18,400 tons in 1969. Catches increased again, leveling off at an average of 68,000 tons during 1971-1975 but decreased in 1976-1977 to an average of 45,000 tons. The 1978 catch of 10,000 tons represented the lowest catch of silver hake on George's Bank since 1955. U.S. catches averaged 18,200 tons during 1955-1963 but declined to average only 3,600 tons during



Figure 5B.

SILVER HAKE CATCH STATISTICS FROM THE GEORGE'S BANK STOCK<sup>1</sup>

Year	Catch (tons)														USA Catch/day (tons)	International effort as USA days fished
	Bulgaria	Canada	Cuba	FRG	GDR	Italy	Japan	Poland	Romania	Spain	USSR	USA	Other	Total		
1955	-	-	-	-	-	-	-	-	-	-	-	19,595	-	19,595	-	-
1956	-	-	-	-	-	-	-	-	-	-	-	20,729	-	20,729	51.50	403
1957	-	-	-	-	-	-	-	-	-	-	-	25,856	-	25,856	51.40	503
1958	-	-	-	-	-	-	-	-	-	-	-	14,498	-	14,498	42.76	339
1959	-	-	-	-	-	-	-	-	-	-	-	15,899	-	15,899	53.51	297
1960	-	-	-	-	-	-	-	-	-	-	-	22,070	-	22,070	35.89	615
1961	-	-	-	-	-	-	-	-	-	-	-	14,468	-	14,468	42.21	343
1962	-	-	-	-	-	-	-	-	-	-	41,900	16,339	-	58,239	39.46	1,476
1963	-	-	-	-	-	-	-	-	-	-	103,697	14,007	-	117,704	29.90	3,937
1964	-	-	-	-	-	-	-	-	-	-	164,763	5,522	-	170,285	41.52	4,101
1965	-	-	-	-	-	-	-	-	-	-	230,666	8,208	-	238,874	24.00	9,953
1966	-	-	-	-	-	-	-	-	-	-	88,086	12,713	-	100,799	26.09	3,864
1967	-	-	-	-	3	-	16	-	-	-	47,348	12,300	-	59,667	31.83	1,875
1968	-	-	-	-	-	-	37	887	-	-	28,013	6,451	14	35,402	25.31	1,399
1969	-	-	-	-	42	-	148	292	7	-	16,144	1,654	119	18,406	13.34	1,380
1970	-	-	-	-	-	-	31	15	73	-	20,548	4,238	-	24,905	23.81	1,046
1971	1,393	-	265	-	-	-	82	124	-	-	66,809	3,069	-	71,742	17.38	4,128
1972	1,914	-	354	226	111	-	104	-	42	-	73,882	879	-	77,512	8.66	8,951
1973	879	-	-	-	145	-	188	251	4	-	55,042	5,698	-	62,207	22.60	2,753
1974	740	1	-	49	36	-	43	70	204	-	62,938	2,283	-	66,364	15.02	4,418
1975	1,021	2	1,304	26	29	-	1	125	122	133	55,795	4,588	49	63,195	22.85	2,766
1976	-	-	3,658	81	-	-	6	102	172	5	37,992	3,793	-	45,809	46.07	994
1977	1,305	-	-	-	-	-	-	-	-	9	39,200	3,749	-	44,263	31.60	1,401
1978	-	-	-	-	-	-	5	-	-	-	3,602	6,394	-	10,001	20.19	495

<sup>1</sup>Non-USA catches before 1968 are estimated.

Source: Almeida and Anderson, 1979.

1968-1978. The 1978 catch of 6,400 tons was the highest since 1968.

During 1973-1975, the TAC was 80,000 tons each year. The 1976 and 1977 TAC's were 50,000 and 70,000 tons respectively. The 1978 OY was set at 58,800 tons. U.S. allocations of the 1973-1977 TAC's were 17,000, 11,056, 11,100, 8,500 and 15,000 tons respectively while actual U.S. catches during this period averaged only about one third of each year's allocation. The amount designated as U.S. capacity in 1978 was 26,000 tons; the actual 1978 catch of 6,400 represents less than 25% of the amount of whiting allocated to the U.S. fleet. Obviously a surplus of whiting exists on George's Bank upon which a directed fishery could be based even without allowing for subsequent growth of the resource.

Until 1969, statistical area 521, which lies east of Cape Cod, produced most of the U.S. catch in Subdiv. 5Ze primarily during the months of June through October. However, area 522 on George's Bank, which includes Cultivator Shoal, has outproduced area 521 frequently since 1969. U.S. fishermen have harvested whiting from this area since 1955, primarily during June through September.

Figure 5B. shows that the foreign fishery for silver hake has been conducted primarily by the U.S.S.R. Beginning in 1962, they have fished nearly all of George's Bank but have focused primarily along the southern reaches of the Bank in statistical areas 524, 525 and 526. The U.S.S.R. has also fished area 522 during the same months of the year as has the U.S.. The seasonal pattern of the U.S.S.R. fishery has varied from year to year but has primarily been conducted during March through August. During 1962-1977, about 77 percent of the catch was taken during these months -- during 1973-1976, March was the predominant month, averaging 30 per cent of the total each year. In 1977, 84 per cent of the U.S.S.R. catch was taken during April through June, with June providing the largest share, totaling 37 per cent.

The NFC reports indicate that the total biomass of whiting on George's Bank increased from 109,300 tons in 1955 (See Figure 6B.) to a high of nearly 800,000 tons in 1963 before declining to 107,600 tons in 1977. Total biomass increased to 420,000 tons in 1975 before declining to an estimated 311,000 tons at the beginning of 1977. As with the Gulf of Maine stock, recruitment was poor during the mid and late 1960's, (See Figure 7B.) but improved in the early 1970's. The 1975 and 1976 year classes were estimated to be poor.

Anderson and Almeida (1979) reported that a total stock biomass of 250,200 tons was believed to be available on Georges Bank at the beginning of 1979, a 19 percent increase from 1978. The spawning stock biomass was estimated to be 201,600 tons in 1979, an increase of 12 percent from 1978. It was estimated that if 1979 and 1980 catches were to stay under 15,000 tons, then allowable catch levels of between 36,000 and 38,000 tons in 1980 would be possible without any decline in the 1981 spawning stock biomass. This means that a potentially great supply of whiting exists on George's Bank if the stocks can be effectively managed.

#### The Southern New England-Middle Atlantic Stock

From 1955 to 1963 this fishery was conducted solely by U.S. fishermen with the catch averaging 12,400 tons per year. (See Figure 8B). In 1963, the U.S.S.R. distant water fleet began to fish for whiting in the Southern New England area. By 1965, the Soviet fleet was harvesting a greater share of the resource than the U.S. fleet. In 1965, the U.S.S.R. catch was nearly 68,500 tons while the U.S. catch was about 21,000 tons; in 1966, the Soviet catch was over 126,000 tons while American fishermen harvested less than 10,000 tons. Distant water fleets of several other nations have also contributed to the international effort to catch whiting in the area since 1967, although

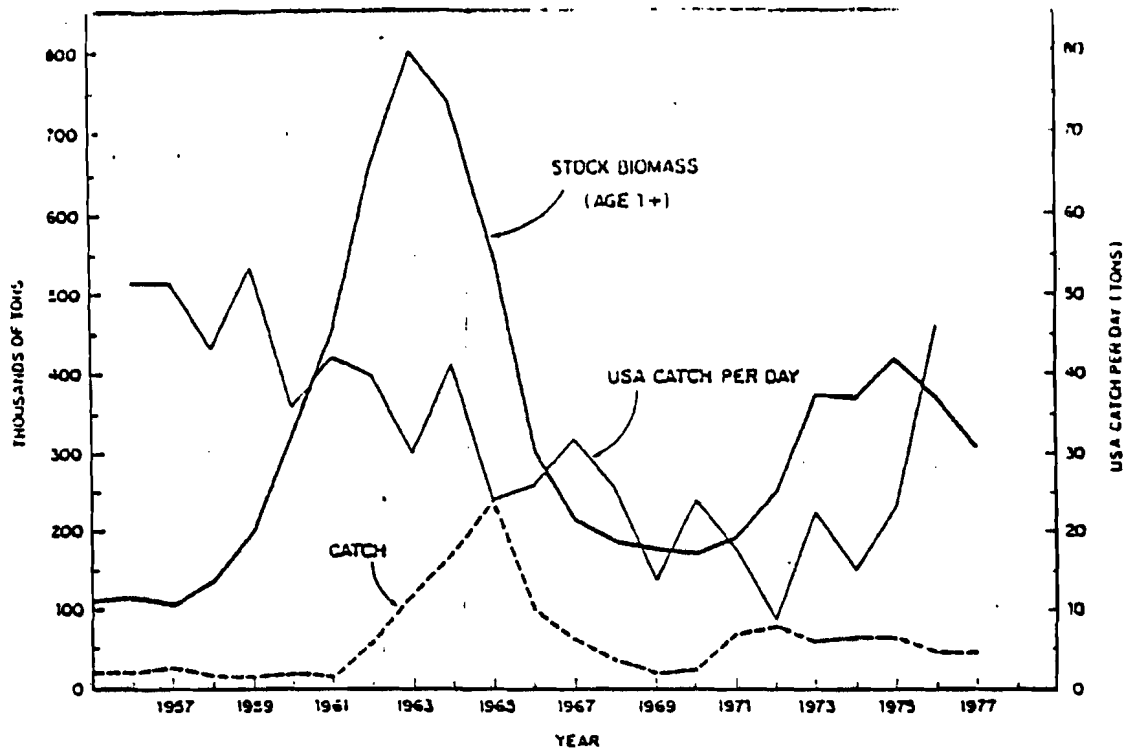

Figure 6B International catch, stock biomass (ages 1 and older) from virtual population analysis, and USA commercial catch per day from the Georges Bank silver hake stock.

Source: Anderson (1978).

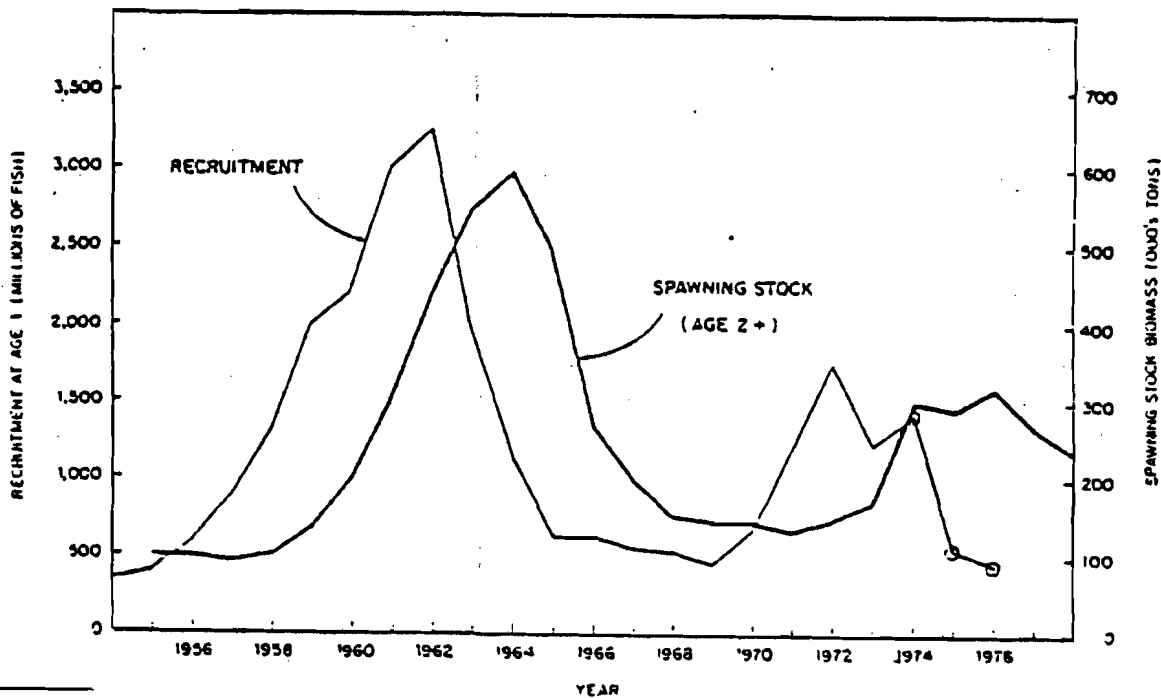

Figure 7B. Georges Bank silver hake spawning stock biomass (ages 2 and older) in 1955-1978 and abundance at age 1 of the 1954-1976 year classes.

Open circles indicate estimated year-class sizes.

Figure 8B.

SILVER HAKE CATCH FROM THE SOUTHERN NEW ENGLAND-MIDDLE ATLANTIC STOCK <sup>1</sup>

Year	Catch (tons)											USA catch/day (tpns)	International effort as USA days fished		
	Bulgaria	Cuba	FRG	GDR	Japan	Poland	Romania	Spain	USSR	USA commercial	USA recreational			Other	Total
1955	-	-	-	-	-	-	-	-	-	12,412	2,743	-	15,155	-	-
1956	-	-	-	-	-	-	-	-	-	13,390	2,959	-	16,349	-	-
1957	-	-	-	-	-	-	-	-	-	15,390	3,400	-	18,790	-	-
1958	-	-	-	-	-	-	-	-	-	12,039	2,660	-	14,699	-	-
1959	-	-	-	-	-	-	-	-	-	15,398	3,402 <sup>2</sup>	-	18,800	-	-
1960	-	-	-	-	-	-	-	-	-	8,151	1,801 <sup>2</sup>	-	9,952	-	-
1961	-	-	-	-	-	-	-	-	-	10,562	2,334	-	12,896	-	-
1962	-	-	-	-	-	-	-	-	-	11,932	2,636	-	14,568	-	-
1963	-	-	-	-	-	-	-	4,191	17,666	2,451	-	24,308	-	-	-
1964	-	-	-	-	-	-	-	19,434	25,008	3,469 <sup>2</sup>	-	47,911	6.90	6,944	-
1965	-	-	-	-	-	-	-	68,493	20,998	2,717 <sup>2</sup>	-	92,208	5.68	16,234	-
1966	-	-	-	-	-	-	-	126,211	9,840	1,365	-	137,416	4.60	29,873	-
1967	-	-	-	-	22	-	-	41,242	8,493	1,178	-	50,935	5.23	9,739	-
1968	-	-	-	-	44	121	-	30,812	8,163	1,132	-	40,272	5.25	7,671	-
1969	746	-	-	2	123	-	-	57,020	7,235	1,003 <sup>2</sup>	-	66,929	6.24	10,726	-
1970	439	-	-	-	299	-	40	11,493	6,005	950 <sup>2</sup>	-	19,226	7.66	2,510	-
1971	621	-	-	-	70	24	432	21,714	4,989	692	-	28,542	4.85	5,885	-
1972	1,629	474	-	16	101	-	127	27,146	5,552	770	-	35,815	6.22	5,758	-
1973	668	-	1	15	268	92	45	57,928	6,098	846 <sup>2</sup>	-	65,961	4.77	13,828	-
1974	1,792	-	-	2	64	70	125	49,175	7,200	1,075 <sup>2</sup>	-	59,503	4.29	13,870	-
1975	896	212	-	8	-	16	-	32,241	8,278	197 <sup>2</sup>	44	41,911	5.26	7,968	-
1976	33	92	-	1	9	113	414	15,780	9,511	1,706 <sup>2</sup>	-	27,661	6.61	4,185	-
1977	114	269	-	-	35	83	12	13,943	9,452	3,948 <sup>2</sup>	11	27,880	7.65	3,644	-
1978	-	-	-	-	268	-	17	9,868	11,405	4,000 <sup>2</sup>	611	26,169	8.40	3,115	-

<sup>1</sup>Non-USA catches before 1968 are estimated.<sup>2</sup>From angler survey; remaining years estimated

the effect of their harvest on the stocks have been minimal in comparison to the intensity of the U.S.S.R. silver hake fishery.

Total catches averaged about 16,800 tons during 1955-1959, declined to 9,952 tons in 1960, and then improved each year to 137,400 tons in 1966. Catches declined sharply to 50,900 tons in 1967 and have since fluctuated between 19,200 and 67,000 tons. Total catches increased steadily from 19,000 tons in 1970 to 66,000 tons in 1973 and then dropped to 26,200 tons in 1978.

The U.S. catch has increased from 5,000 tons in 1971 to 11,400 tons in 1978 except for a 100 ton decrease in catch between 1976-1977. During 1955-1965, U.S. Commercial catches ranged between 8,151 and 25,008 tons, averaging about 14,800 tons each year. During this time, a large industrial market existed for silver hake. (Industrial processing reduces round fish to fish meal and oil). Catches during 1966-1978 were lower as a result of the closing of a major reduction plant, ranging between 4,989 and 11,405 tons and averaging only 7850 tons each year. Estimated U.S. recreational catches in the area during 1955-1978 ranged from 682 and 4,000 tons and averaged about 2050 tons each year.

The ICNAF TAC for the Southern New England-Middle Atlantic stock was 80,000 tons per year during 1973-1975, 43,000 tons in 1976, and 45,000 tons in 1977. The 1978 OY was set at 33,200 tons. U.S. allocations during 1973-1977 were 25,000, 18,864, 18,900, 9,000, and 12,500 (with an additional 2,000 for the U.S. recreational fishery) tons, respectively. The 1978 OY was increased by 5,000 tons in mid-year, all of which was allocated as TALFF. In 1979, the OY was increased to 40,000 tons of which 20,600 tons was allocated to U.S. fishermen; over 5,000 tons of this amount was not taken, indicating another substantial surplus of whiting available to the industry.

The U.S. whiting fishery in Subdiv. 5ZW is conducted throughout the entire year, although the peak catches in most years have been during May through July. Statistical area 539 has usually contributed the largest share from southern New England waters. The U.S. fishery in Statistical area 6 is primarily in Division 6A and is conducted mainly from November through May.

As with the George's Bank stock, the foreign fishery for silver hake in this area has been conducted, primarily, by the U.S.S.R. They have fished in all areas of Subdiv. 5ZW and statistical area 6, with the largest share in most years coming from 5ZW. Catches have been taken in all months although most of it has come during February through April; during 1969-1972, the largest catches came during June through August.

Anderson (1978) reported that total stock biomass (ages 1 and older) increased from an average of 76,000 tons during 1955-1959 to a high of 454,000 tons in 1965 and decreased to 82,000 tons in 1970. (See Figure 9B.) Biomass increased to 210,000 tons in 1973, decreased to an average of 188,000 tons during 1975-1976 and then increased to an estimated 307,000 tons by 1978.

Spawning stock biomass (ages 2 and older) averaged about 60,000 tons during 1955-1960 before increasing to a high of 376,000 tons in 1965. (See Figure 10B). This biomass declined to 66,000 tons in 1970-1971, increased to an average of 151,000 tons in 1973-1974, dropped to 100,000 tons in 1975 and increased to nearly 250,000 tons in 1978; the highest level since 1966.

Anderson and Almeida (1979) estimate that a total stock biomass of 327,600 tons was available at the beginning of 1979. The available spawning stock was estimated to be 254,200 tons. These estimates represent an 18 percent increase in total stock biomass and a 19 percent increase in spawning stock biomass from 1978. They further estimated that if 1979 and 1980 catches varied between 15,000 and 25,000 tons, then allowable catch levels of

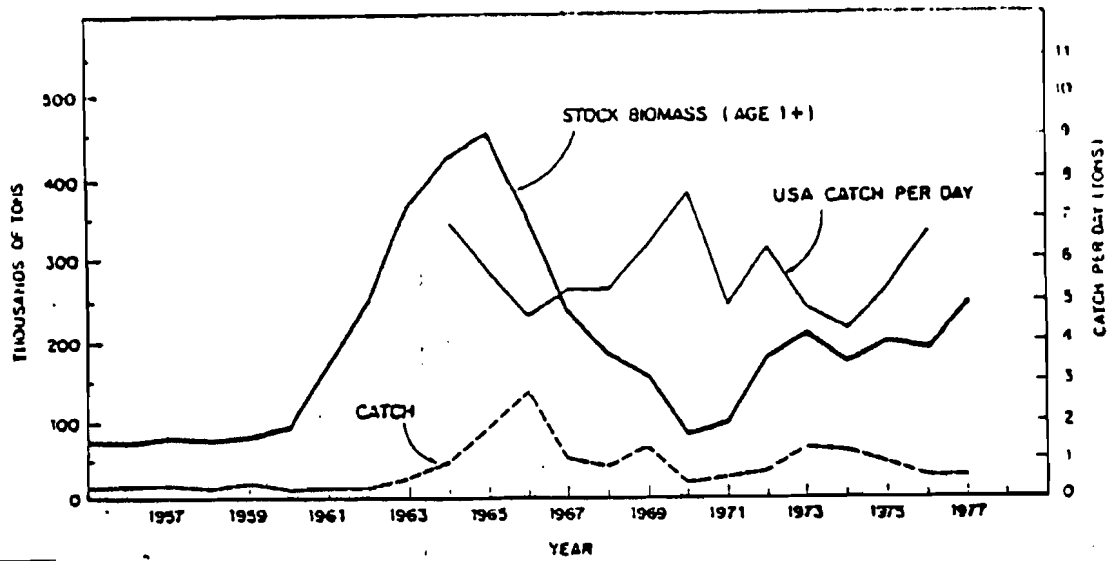

Figure 9B. International catch, stock biomass (ages 1 and older) from virtual population analysis, and USA commercial catch per day from the Southern New England-Middle Atlantic silver hake stock.

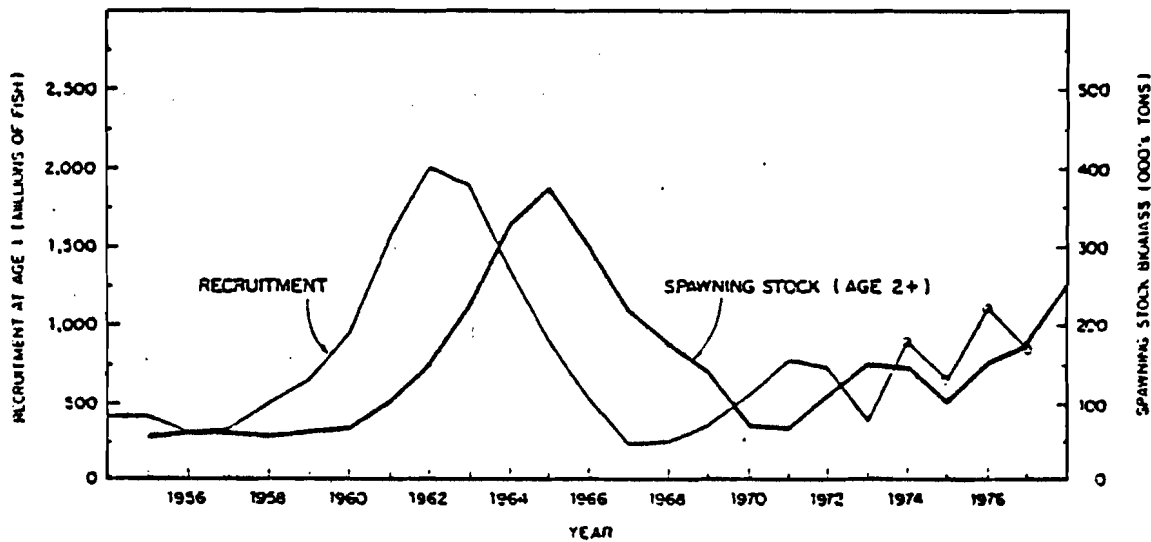

Figure 10 B. Southern New England-Middle Atlantic silver hake spawning stock biomass (ages 2 and older) in 1955-1978 and abundance at age 1 of the 1954-1977 year classes. Open circles indicate estimated year-class sizes.

Source: Anderson (1978).



between 38,300 and 39,600 tons in 1980 would be possible without any decline in the 1981 spawning stock biomass. As on George's Bank, a large potential supply of whiting exists in the Southern New England-Middle Atlantic area.

The Fishery Conservation and Management Act of 1976 instructs the Regional Councils to use the best available scientific evidence when making their fishery management decisions. Anderson and Almeida's studies, published by the National Marine Fisheries Service's Northeast Fishery Center, represent the best available scientific evidence pertaining to the status of the silver hake stocks.

The studies indicate that a significant surplus supply of whiting is available both in the George's Bank area and in the Southern New England-Middle Atlantic Area. In these two areas, nearly 80,000 tons of whiting are estimated to be harvestable annually without diminishing the size of the species' spawning stock. In 1978, less than 30,000 tons of whiting were harvested by domestic fishermen and only 13,760 tons were harvested by foreign fleets. Assuming that the entire 80,000 tons could be taken--over 36,000 tons were not harvested in 1978. If this amount was caught and processed as fillet blocks (assuming a 20 percent fillet yield), nearly 18 million pounds of blocks could have been produced. This figure represents nearly half of the 40 million pounds of whiting fillet blocks imported into the United States in 1978.

The size and condition of the whiting resource does not appear to be a limiting factor in the development of the whiting fishery.

NOTES (For Appendix B)

- <sup>1</sup>Earl R. Coombs, Inc., Venture Analysis and Feasibility Study Relating to Whiting and Atlantic Mackerel, for the New England Fisheries Development Program and the NMFS, December 1977, at page 10.
- <sup>2</sup>see Bigelow, H.B. and W.C. Schroeder, Fishes of the Gulf of Maine, Fishing Bulletin No. 74 of the Fish and Wildlife Service Volume 53, U.S. Govt. Printing Office, Washington, D.C. 1953 at pp. 173-184. and Olsen, J.B. and D.K. Stevenson, Commercial Marine Fish and Fisheries of Rhode Island, The Coastal Resources Center, University of Rhode Island Marine Technical Report 34, Kingston, 1975, at pp. 81-82.
- <sup>3</sup>Statistical Abstract of the United States, U.S. Department of Commerce, Bureau of the Census, 1979, at pp. 738.
- <sup>4</sup>90 Stat. 331, P.L. 94-265, 16 U.S.C. 1801-1882.
- <sup>5</sup>The FCMA defines optimum yield as being the amount of fish:
1. which will provide the greatest overall benefit to the Nation, with particular reference to food production, and recreational opportunities; and
  2. which is prescribed as such on the basis of the maximum sustainable yield from such fishery, as modified by any relevant economic, social, or ecological factor.
- TALFF (Total Allowable Level of Foreign Fishery) is determined by subtracting the anticipated harvesting capabilities of U.S. vessels for the fishing year from the fishery's calculated optimum yield of OY.
- <sup>6</sup>Earl, P.M., Silver Hake ... A Prospectus, Fisheries Development Services Branch, NMFS, Gloucester, MA, at page 1.
- <sup>7</sup>Anderson, E.D. and F.P. Almeida, Status of the Silver Hake Resource off the Northeast Coast of the United States -- 1979, Laboratory Reference No. 79-48, NMFS, Northeast Fisheries Center, Woods Hole, MA., 2 November 1979 and; \_\_\_\_\_, Resource Implications of an Expanded Silver Hake Fishery, Laboratory Reference No. 78-34, NMFS, Northeast Fisheries Center, Woods Hole, MA. 2 June, 1978. -- Results from these two reports will not be distinguished within this paper's analysis.

Appendix C.

HARVESTING CAPABILITIES

Figure 1C shows the amount of whiting caught using various harvesting methods in Rhode Island and Massachusetts during 1975. These two states have traditionally supplied the majority of whiting to Atlantic coast processors. Bottom trawling is the most efficient method of harvesting whiting and this method can be expected to supply the whiting that would be needed if domestic processors began to produce whiting fillet blocks. A brief discussion of the several fishing methods that have been used to catch whiting will follow.<sup>1</sup> Problems associated with increasing the fishing effort to harvest whiting are also discussed.

Floating Traps

Traps are employed in areas where fish congregate or regularly move. Once the fish enters the trap, they are effectively contained until the tending vessel removes them. Traps are generally set in shallow water immediately offshore. Some traps have a bottom of netting while others have a net bottom only in the pocket area, allowing the sea bed to guide the fish into the net.

Figure 2C shows typical East Coast fish trap configurations. When the fish run into the leader, they are herded along the twine into the trap's pocket where they are contained in a relatively small area. The tending vessel returns to the trap daily and "dries up" the pocket by hauling the twine on board so that the catch may be brailed or dumped into the boat.

Whiting are found close to shore only during the summer months of the year, therefore, traps will be of little importance in supplying processors the year-around supply of whiting that will be needed if full-scale production of fillet blocks

WHITING HARVESTING -- TYPES OF GEAR EMPLOYED

(R.I. AND MASS. LANDINGS -- 1975)

	BOTTOM TRAWLS		FLOATING TRAPS		MIDWATER TRAWLS		GILL NETS	
	Pounds	Dollars	Pounds	Dollars	Pounds	Dollars	Pounds	Dollars
R.I.	5,290,200	443,171	54,900	7,153	1,700	128	300	28
MASS.	26,617,100	2,237,322	--	--	--	--	--	--

Source: Fishery Statistics of the U.S., 1975.

Figure 1C.

2C.

Figure 2C.

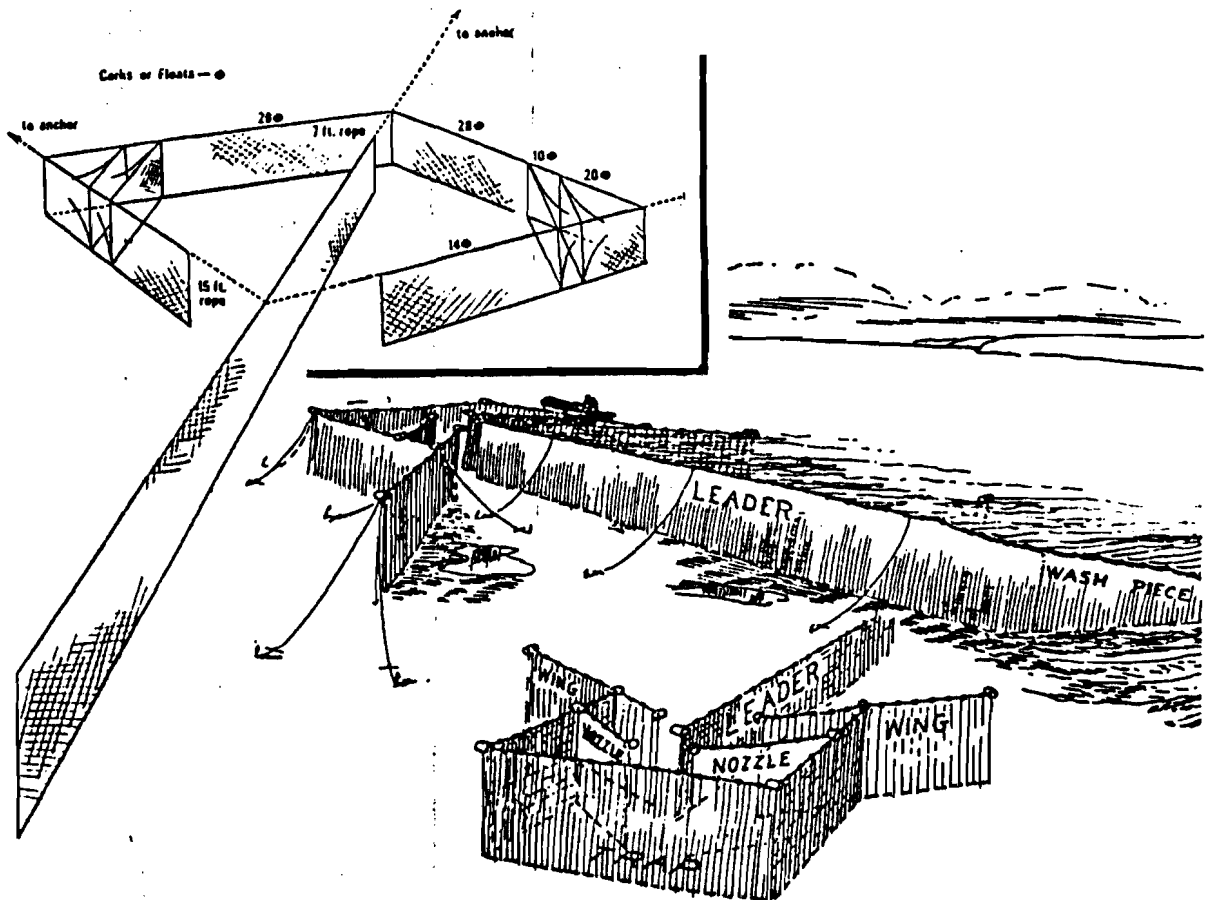

Typical fish traps. Many variations in design are found from country to country and area to area, depending on local traditions and needs.

Top: Northumberland and Salmon "T" net, as used in the British Isles.

Bottom: design of trap common to the New England area of the U.S.A. The floating trap is constructed to fish from surface to bottom, and is therefore built to suit its location. The trap is held in position by a series of anchors and buoys; the leader net is often made fast to a ring bolt ashore. The wash piece is portable, being used only when certain species are running which tend to hug the shore.

Source: Sainsbury, (1971).

becomes a reality.

### Mid-Water Trawls

The mid-water trawl net is more conical in shape than the flatter bottom trawl. These nets are generally constructed from four panels of twine joined to form a box shape with small wings at each corner. (See Figure 3C.)

During normal operation, the net does not come into contact with the sea floor except in very shallow water. The net is, therefore, of relatively light construction enabling a vessel to tow a larger mid-water trawl than it could a bottom trawl with its heavier net and bottom gear. Mid-water trawls can be towed by single boat or by pair-trawling methods with the pair-trawlers able to tow a larger net. Since whiting are a demersal (bottom dwelling) fish, relatively few are harvested by mid-water trawls.

### Gill Nets

The gill net may consist of one layer of twine in which fish are trapped by their gills or several layers of twine of various mesh sizes in which they become tangled (tangle nets). See Figure 4C.) The top of the net is seized to a float line and the bottom to a headline. Gill nets may be set either just above the sea floor when fishing for demersal species, or suspended in the water at various depths when fishing for pelagic (mid-water) species. Gill nets may extend end to end for long distances or in smaller sections depending on the peculiarities of the area being fished. They may be set or hauled over the side or over the stern of a vessel and are usually hauled with the aid of a hydraulic power block.

Gill netting usually takes place in a high-value fishery such as in the west-coast salmon fishery. A fisherman could not be expected to be able to earn a living harvesting

Figure 3C.

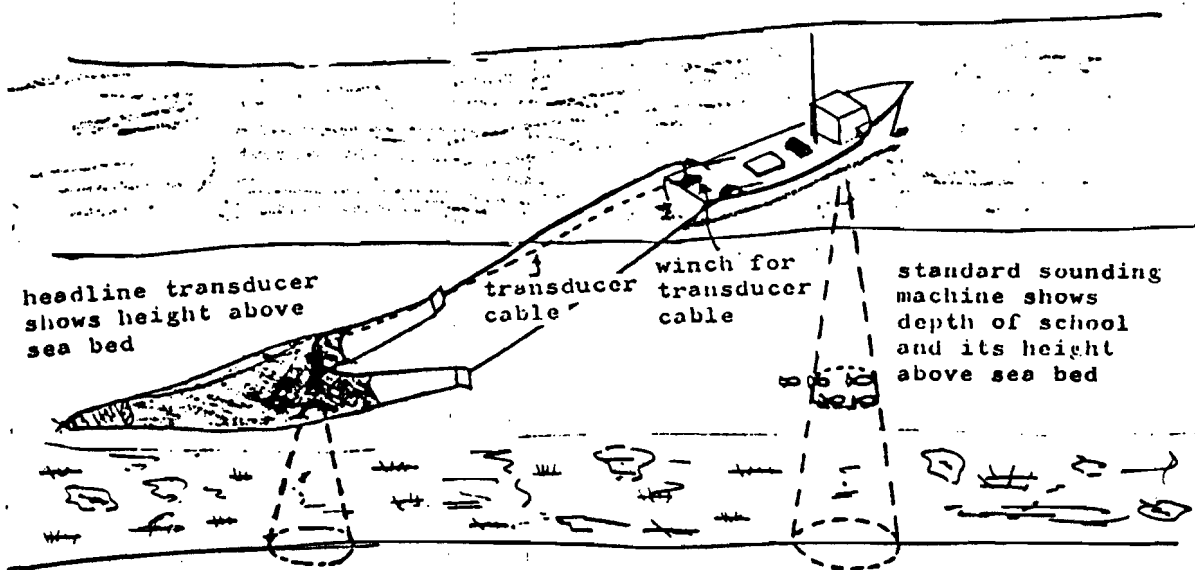

One boat mid-water trawling. Although the net is similar to a cone, the operation is very much the same, and may be undertaken by vessels outfitted for bottom trawling. An additional winch is used to handle the electrical cable from the headline transducer on the net. Signals from the transducer are fed to a sounding machine aboard the vessel, and allow the net to be set to tow at the correct depth.

Source: Sainsbury (1971).

Figure 4C.

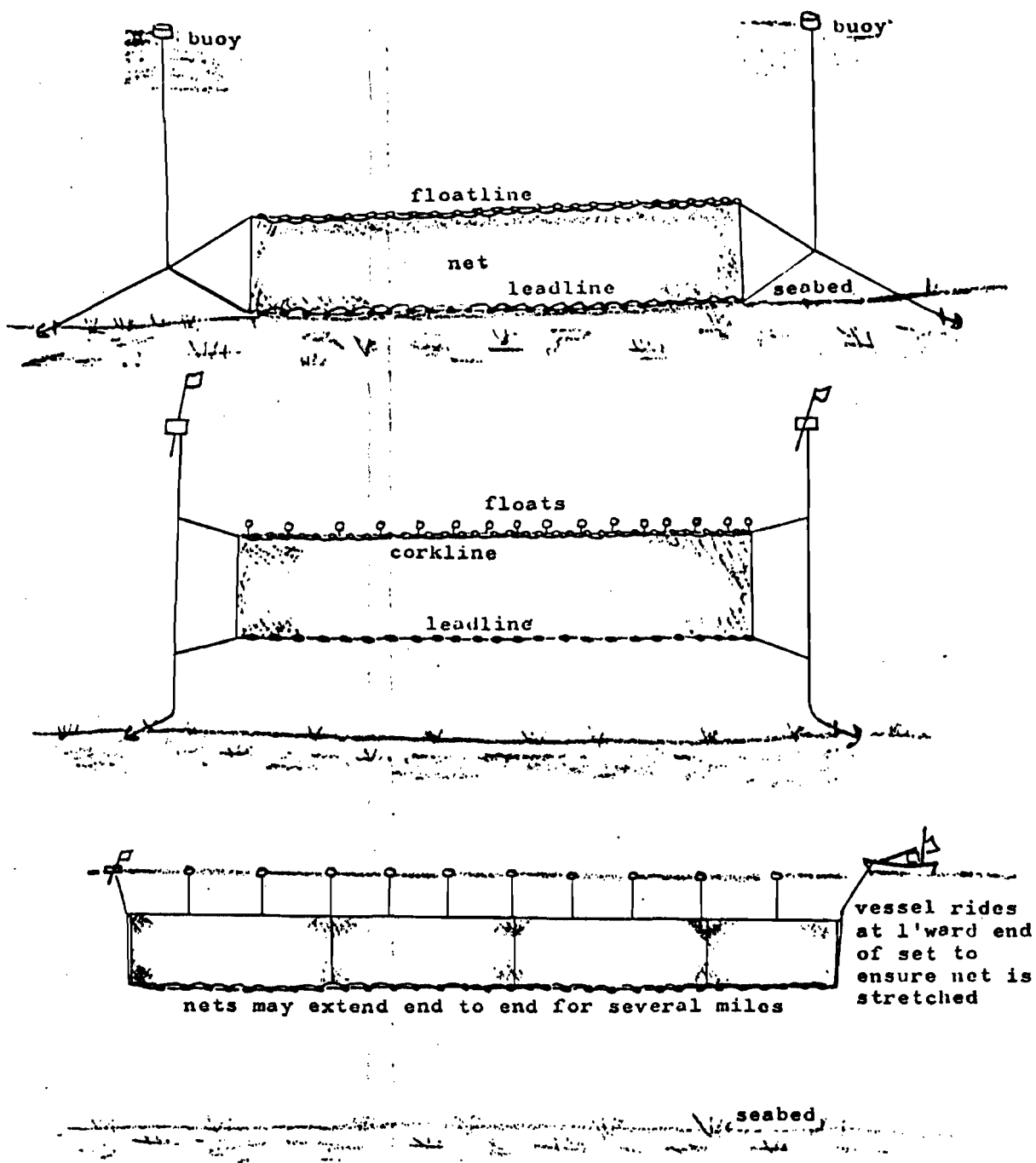

Various methods of setting gillnets.  
Top: bottom gillnet.  
Middle: mid-water gillnet.  
Bottom: drift net; surface gillnet.

Source: Sainsbury (1971).



whiting with gill nets due to the fish's low price. Further, gill netting for whiting would only be feasible during the summer months of the year when the fish can be found in relatively shallow water close to shore. This fishing method could not be expected to provide a year-around supply of whiting to processors.

### Bottom Trawls

Bottom trawls are large bags of twine hauled along the sea bed to harvest fish on or near the bottom. (See Figure 5C.) Depending on the configuration of the trawl's bottom gear, the net can be rigged to catch fish on various types of bottom.

The mouth of the net takes up somewhat of an oval shape with two wings stretching out in front on either side of the mouth to increase the size of the area swept by the trawl. Floats are arranged along the net's headrope to keep the mouth opened and the sweep is weighted in various ways to allow the net to dig in or roll along the bottom to "scare up" the fish. The headrope and top square of the net usually overhangs the footrope to herd fish, disturbed by the trawl's action, along the bottom into the belly of the trawl.

As was mentioned above, bottom trawling catches the majority of the whiting that is harvested. It is this method of fishing that will be able to supply processors with a year-around supply of whiting. Bottom trawling is employed by New England and Middle Atlantic fishermen catching cod, haddock, yellowtail flounder and other bottom fish twelve months out of the year. If the producer of whiting fillet blocks can pay fishermen enough for their catch, whiting can also be harvested in New England twelve months out of the year.

Since the implementation of the FCMA, many fishermen have purchased trawlers over seventy feet in length that have the ability to work the offshore grounds in all types of weather.

Figure 5C.

THE BOTTOM TRAWL

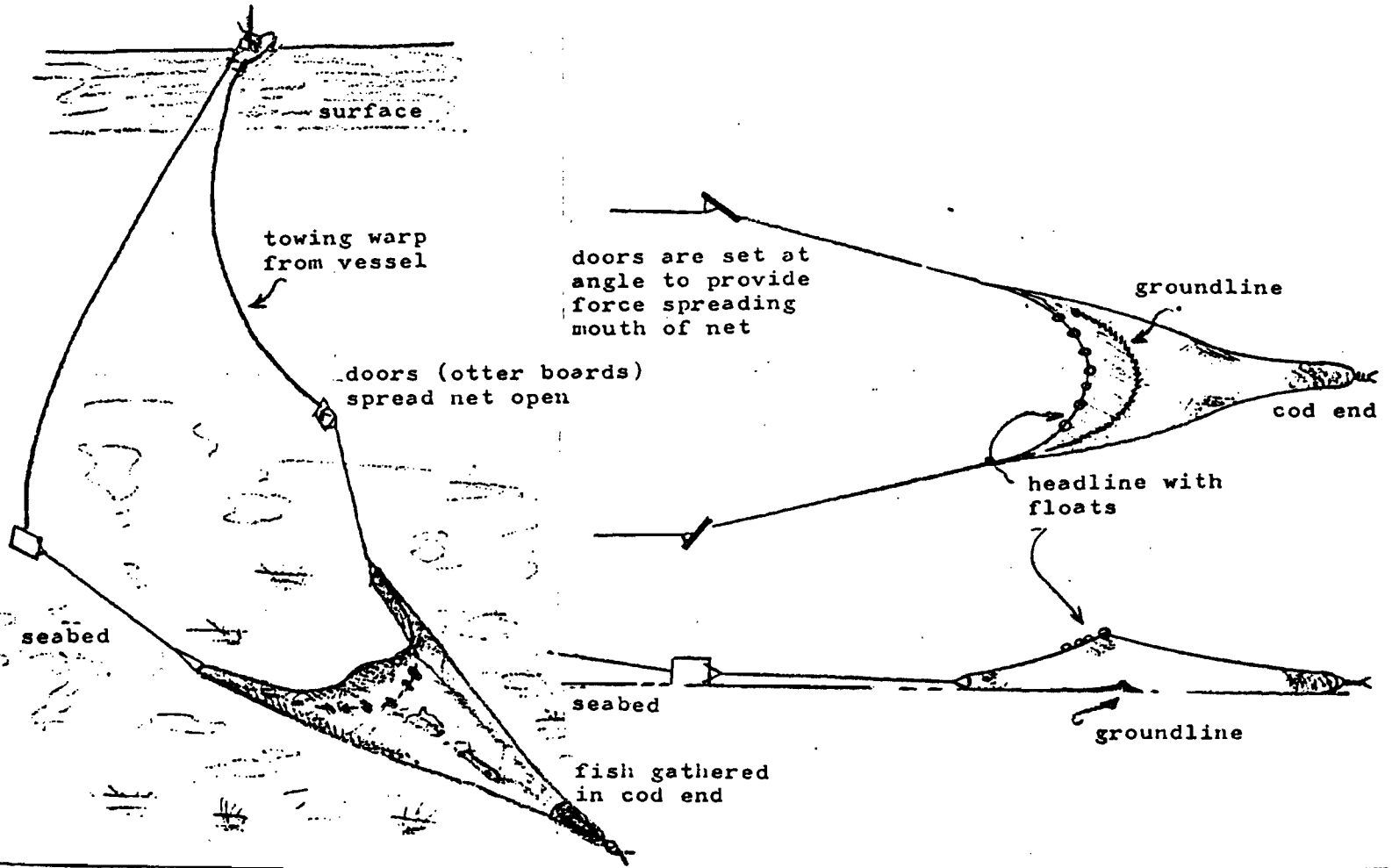

Source: Sainsbury (1971).

Figure 6C. indicates that in 1977, twenty-one large vessels were constructed for New England fishermen. Middle Atlantic fishermen had four vessels over seventy feet long built for them in the same year. Figure 7C. indicates a three-fold increase in the number of new fishing vessels constructed in 1977 over 1975. Figure 8C. indicates that growth in the industry has been significant since as early as 1965. All of this indicates to me that a large harvesting capacity exists in the commercial fishing industry. This is an assumption made by each person that I have contacted regarding the expansion of the whiting industry. The key to the availability of a sufficient portion of that harvesting capacity lies in the price that processors are willing to pay fishermen to fish for whiting. That price is a subjective figure that cannot be quoted here.

Although there appears to be a good potential for expanding the harvest of whiting both in terms of resource availability and in terms of harvesting capacity, several problems are associated with that expansion.

Expanded efforts along the continental shelf could result in conflict between U.S. lobster fishermen and whiting (bottom) fishermen working the same grounds in some of the prime offshore whiting areas. This gear conflict problem existed when the foreign silver hake fishery was more extensive than it is today.<sup>2</sup>

If an intensive winter-spring fishery for whiting was developed in offshore overwintering areas before the inshore spawning migrations, the availability of fish in the inshore areas during the summer may be greatly diminished. This may be particularly the case with the Southern New England-Middle Atlantic stock. U.S. fishermen argued successfully in the late 1960's that the U.S.S.R. hake fishery was causing this problem which led to the ICNAF hake management area during 1970-1974 that prohibited fishing for all hake during January thru March in 1970-1972 and during April in 1973-1974.<sup>3</sup>

Figure 7C.

VESSELS CONSTRUCTED FOR THE DOMESTIC FISHING FLEET, BY AREA, 1975-77

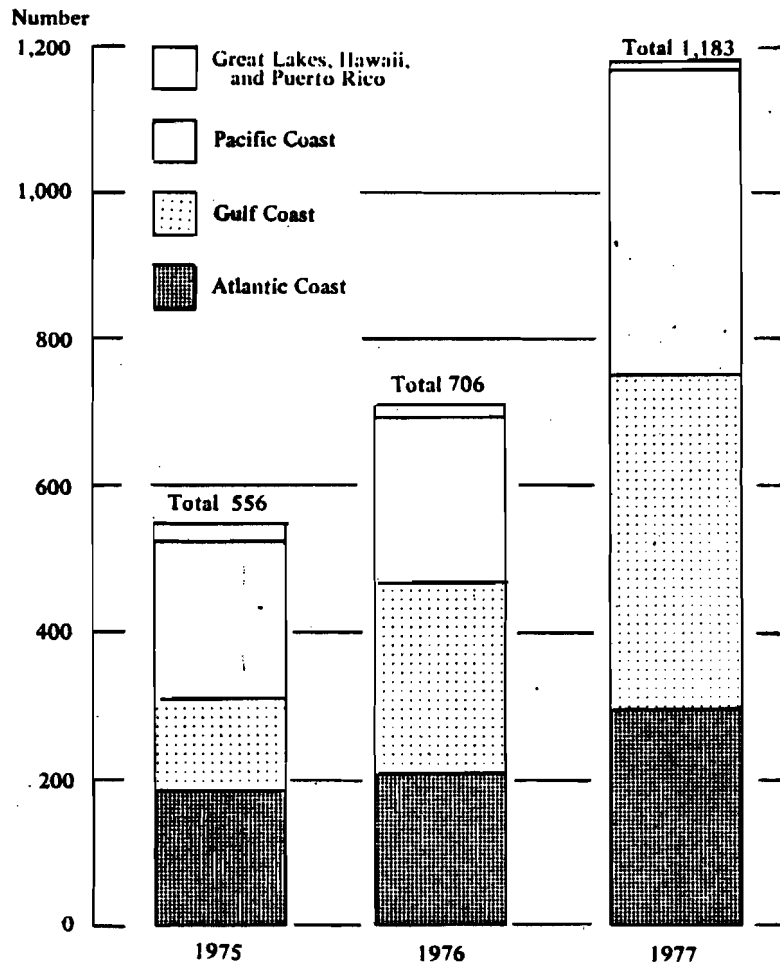

Source: Fisheries of the United States, 1978.

Figure 6C.

## VESSELS CONSTRUCTED IN 1977 FOR THE U.S. FISHING FLEET

Gross tonnage	By tonnage groups								Total
	New England	Middle Atlantic	Chesa- Peake	South Atlantic	Gulf	Pacific Coast	Great Lakes	Hawaii	
	----- Number -----								
5 - 9	19	3	19	10	24	70	-	2	147
10 - 19	35	3	25	32	61	166	4	2	328
20 - 29	3	3	3	23	46	63	1	2	144
30 - 39	6	3	1	15	30	46	1	1	103
40 - 49	4	1	-	3	25	28	-	-	61
50 - 59	4	1	-	5	16	6	-	-	32
60 - 69	2	-	-	3	12	5	-	1	23
70 - 79	-	-	-	5	6	8	-	-	19
80 - 89	-	1	1	6	21	4	-	-	33
90 - 99	2	1	1	11	66	-	-	-	81
100 - 109	-	-	2	8	60	-	-	-	70
110 - 119	1	-	1	3	33	1	-	-	39
120 - 129	1	-	-	-	30	2	-	-	33
130 - 139	4	1	1	-	2	1	-	-	9
140 - 149	10	1	1	2	12	1	-	-	27
150 - 159	-	-	-	1	2	-	-	-	3
160 - 169	2	-	1	-	6	-	-	-	9
170 - 179	1	1	-	-	1	1	-	-	4
180 - 189	1	1	-	-	-	1	-	-	3
190 - 199	2	-	-	-	1	6	-	-	9
260 - 269	-	-	-	-	1	-	-	-	1
460 - 469	-	-	-	-	1	-	-	-	1
530 - 539	-	-	-	-	1	-	-	-	1
630 - 639	-	-	-	-	1	-	-	-	1
1150 - 1159	-	-	-	-	-	2	-	-	2
<b>Total vessels</b>	<b>97</b>	<b>20</b>	<b>56</b>	<b>127</b>	<b>458</b>	<b>411</b>	<b>6</b>	<b>8</b>	<b>1,183</b>
	-----								
Length in feet	By length distribution								Total
	New England	Middle Atlantic	Chesa- peake	South Atlantic	Gulf	Pacific Coast	Great Lakes	Hawaii	
	----- Number -----								
20 - 29	15	3	6	9	12	121	1	2	169
30 - 39	41	4	26	41	86	163	1	3	365
40 - 49	9	5	15	32	73	89	4	2	229
50 - 59	6	3	1	11	37	19	-	1	78
60 - 69	5	1	5	26	189	7	-	-	233
70 - 79	15	2	3	7	50	2	-	-	79
80 - 89	5	1	-	1	7	3	-	-	17
90 - 99	1	1	-	-	1	4	-	-	7
160 - 169	-	-	-	-	3	1	-	-	4
200 - 209	-	-	-	-	-	2	-	-	2
<b>Total vessels</b>	<b>97</b>	<b>20</b>	<b>56</b>	<b>127</b>	<b>458</b>	<b>411</b>	<b>6</b>	<b>8</b>	<b>1,183</b>

Source: Fisheries of the United States, 1978.

Figure 8C.

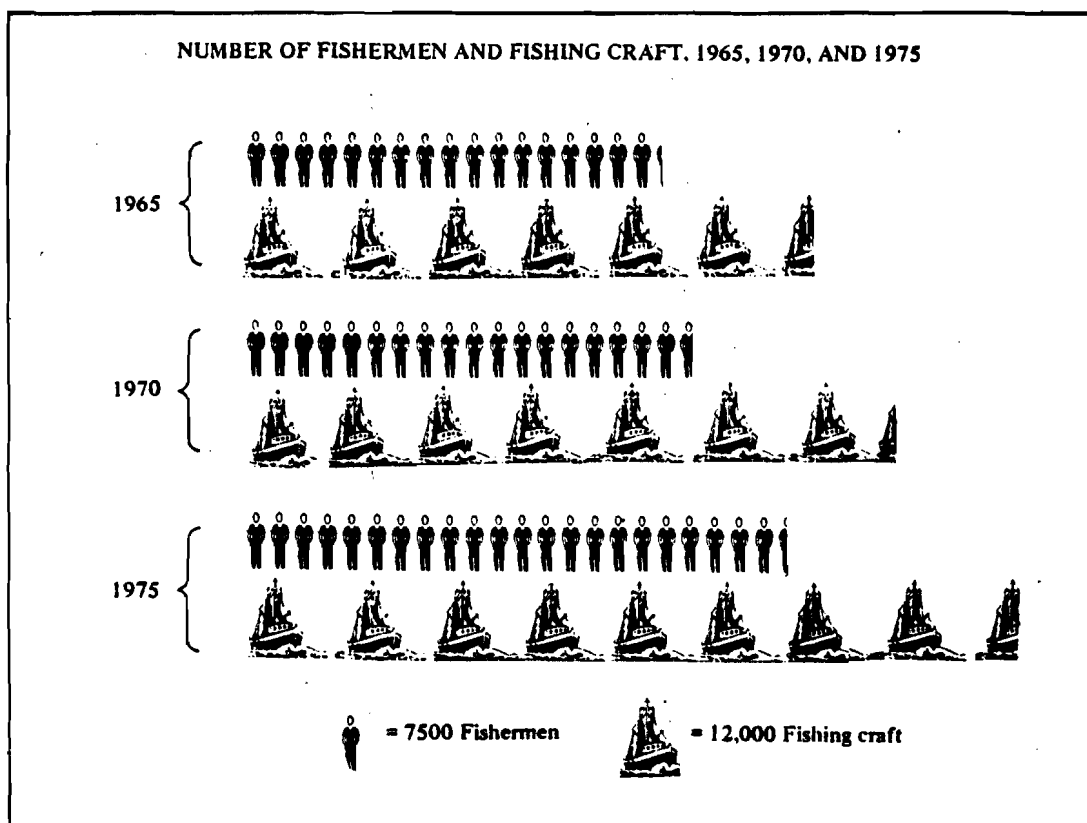

Source: Fisheries of the United States, 1978.

The foreign whiting fishery has a 60 mm (2.3 inch) mesh regulation. Currently, U.S. fishermen do not have a minimum mesh size regulation. Anderson's silver hake<sup>4</sup> stock assessment warns against the expansion of a U.S. whiting fishery without a 60 mm minimum mesh size limit instituted.

An October article in the National Fisherman<sup>5</sup> illustrated the need for mesh size restrictions in a report on the decline in Gloucester whiting landings last summer. The article mentioned a mounting suspicion that heavy fishing with small mesh nets may be the problem. Gloucester inshore fishermen were reported to suspect fishing on the offshore grounds, with meshes of less than 2 inches, as causing the poor recruitment of the inshore whiting fishery.

Some fishermen will argue, however, that small mesh nets are necessary to catch whiting because they are the only fish that "fight the twine", or swim against it in an effort to escape.<sup>6</sup> These efforts are believed to be successful unless a 2-inch (or smaller) mesh is used in the trawl.

Cod and flounder fishermen will sew a two-inch mesh top belly and cod end into their net when they switch over to the whiting fishery. Fishermen who work on whiting regularly will often use a net made entirely of 2-inch twine.

Mesh-size regulations will undoubtedly be applied to the whiting fishery if an expansion occurs.

Anderson writes that an expanded whiting fishery will not necessarily relieve pressure on the cod, haddock and yellowtail stocks in all areas. The Southern New England-Middle Atlantic silver hake stock offers the greatest potential for expansion yet catches of cod and haddock are less in that area than on George's Bank or in the Gulf of Maine. In the Gulf of Maine, there is a need for a species to provide an alternative to cod and haddock, yet little potential to expand the whiting fishery in that area exists unless the postponement of the rebuilding of that stock takes place.<sup>7</sup>

The cautions that have just been discussed are all valid considerations although I do not believe that the expansion of the whiting fishery should be limited, at this time, for any of them.

The production of whiting blocks will be slow to increase if, indeed, it becomes a feasible venture. Today, only one plant is experimenting with the process and it will take time before others become involved. The first processors who take the initiative in developing and marketing a nontraditional product, such as whiting fillet blocks, should not have their supply of raw product limited through overzealous stock regulations. If it becomes evident that the processing enterprise will be successful and that competition on the whiting grounds becomes so great as to threaten the condition of the stock, then the Regional Councils should take the matter into consideration.

The harvesting capacity for an expanded whiting fishery is available. The whiting block processor's demand for raw materials can be met if ex-vessel price is high enough to motivate the fleet.



END NOTES

APPENDIX C.

- <sup>1</sup>The descriptions of fishing methods are based upon those contained in Commercial Fishing Methods, J.S. Sainsbury, Fishing News (Books) Ltd., London, England, 1971.
- <sup>2</sup>Anderson, E.D., Resource Implications of an Expanded U.S.A. Silver Hake Fishery, NMFS, Northeast Fisheries Center, Woods Hole, Mass. 2 June, 1978, 10.
- <sup>3</sup>ibid at 4.
- <sup>4</sup>ibid
- <sup>5</sup>"Small-Mesh Nets Blamed For Bust of Whiting Stocks," National Fisherman, October 1979, 10.
- <sup>6</sup>Personal communication with George Gamache, Fisheries Technology instructor, University of Rhode Island.
- <sup>7</sup>Note 2 supra at all.