

University of Rhode Island

DigitalCommons@URI

---

PHY 204: Elementary Physics II -- Slides

PHY 204: Elementary Physics II (2021)

---

2020

## 16. Faraday's law. Motional EMF. Lenz's rule

Gerhard Müller

University of Rhode Island, gmuller@uri.edu

Robert Coyne

University of Rhode Island, robcoyne@uri.edu

Follow this and additional works at: <https://digitalcommons.uri.edu/phy204-slides>

---

### Recommended Citation

Müller, Gerhard and Coyne, Robert, "16. Faraday's law. Motional EMF. Lenz's rule" (2020). *PHY 204: Elementary Physics II -- Slides*. Paper 41.

<https://digitalcommons.uri.edu/phy204-slides/41>

This Course Material is brought to you by the University of Rhode Island. It has been accepted for inclusion in PHY 204: Elementary Physics II -- Slides by an authorized administrator of DigitalCommons@URI. For more information, please contact [digitalcommons-group@uri.edu](mailto:digitalcommons-group@uri.edu). For permission to reuse copyrighted content, contact the author directly.



Conducting rod moving across region of uniform magnetic field

- moving charge carriers
- magnetic force  $\vec{F}_B = q\vec{v} \times \vec{B}$
- charge separation
- electric field  $\vec{E}$
- electric force  $\vec{F}_E = q\vec{E}$

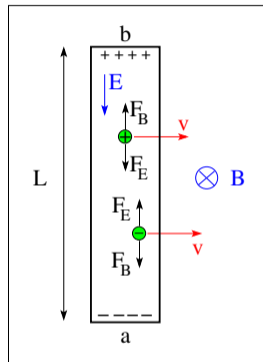

Equilibrium between electric and magnetic force:

$$F_E = F_B \Rightarrow qE = qvB \Rightarrow E = vB$$

Potential difference induced between endpoints of rod:

$$V_{ab} \equiv V_b - V_a = EL \Rightarrow V_{ab} = vBL \quad (\text{motional EMF})$$

# Current Produced by Motional EMF



- Motional EMF:  $\mathcal{E} = vBL$
- Terminal voltage:  $V_{ab} = \mathcal{E} - Ir$
- Electric current:  $\mathcal{E} - Ir - IR = 0 \Rightarrow I = \frac{\mathcal{E}}{r + R}$
- Applied mechanical force:  $\vec{F}_{app}$
- Magnetic force:  $\vec{F}_B = I\vec{L} \times \vec{B}$
- Motion at constant velocity:  $\vec{F}_{app} = -\vec{F}_B$
- Electrical power generated:  $P_{gen} = \mathcal{E}I$
- Mechanical power input:  $P_{in} = Fv = (ILB)v = (vBL)I = \mathcal{E}I$
- Electrical power output:  $P_{out} = V_{ab}I = \mathcal{E}I - I^2r$

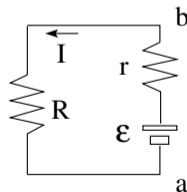
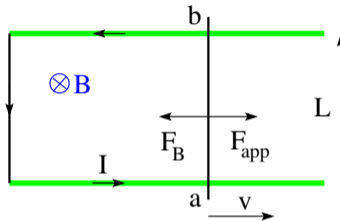

# Faraday's Law of Induction (1)



Prototype: motional EMF reformulated.

- Choose area vector  $\vec{A}$  for current loop:  $A = Ls \odot$ .
- Magnetic flux:  $\Phi_B = \int \vec{B} \cdot d\vec{A}$ . Here  $\Phi_B = -BLs$ .
- Motional EMF:  $\mathcal{E} = vBL$ .
- Change in area of loop:  $dA = Lds$ .
- Change in magnetic flux:  $d\Phi_B = -BdA = -BLds$ .
- SI unit of magnetic flux:  $1\text{Wb}=1\text{Tm}^2$  (Weber).
- Rate of change of flux:  $\frac{d\Phi_B}{dt} = -BL\frac{ds}{dt} = -vBL$ .
- Faraday's law:  $\mathcal{E} = -\frac{d\Phi_B}{dt}$ .

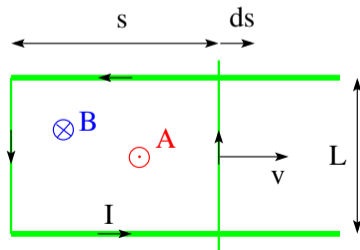



$$\Phi_B = \int \vec{B} \cdot d\vec{A}, \quad \mathcal{E} = \oint \vec{E} \cdot d\vec{\ell} = -\frac{d\Phi_B}{dt}$$

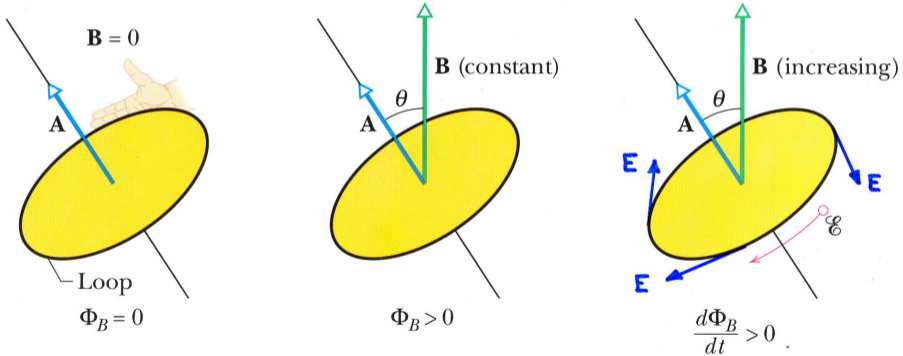



$$\Phi_B = \int \vec{B} \cdot d\vec{A}, \quad \mathcal{E} = \oint \vec{E} \cdot d\vec{l} = -\frac{d\Phi_B}{dt}$$

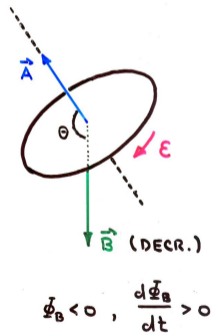
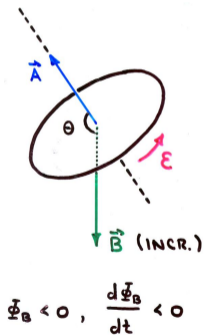
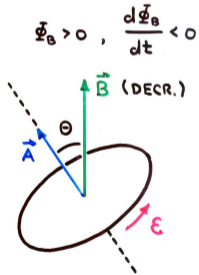
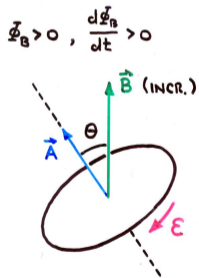

# Faraday's Law of Induction (2)



Here the change in magnetic flux  $\Phi_B$  is caused by a moving bar magnet.

- Assume area vector  $\vec{A}$  of loop pointing right.  
Hence positive direction around loop is clockwise.
- Motion of bar magnet causes  $\frac{d\Phi_B}{dt} > 0$ .
- Faraday's law:  $\mathcal{E} = -\frac{d\Phi_B}{dt}$ .
- Induced EMF is in negative direction,  $\mathcal{E} < 0$ ,  
which is counterclockwise.
- Induced EMF reflects induced electric field:  $\mathcal{E} = \oint_C \vec{E} \cdot d\vec{\ell}$ .
- Field lines of induced electric field are closed.
- Faraday's law is a dynamics relation between electric and magnetic fields:  $\oint_C \vec{E} \cdot d\vec{\ell} = -\frac{d}{dt} \int_S \vec{B} \cdot d\vec{A}$ .

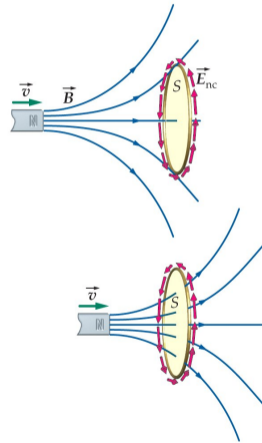

## Magnetic Induction: Application (3)



A uniform magnetic field  $\vec{B}$  pointing into the plane and increasing in magnitude as shown in the graph exists inside the dashed rectangle.

- Find the magnitude (in amps) and the direction (cw/ccw) of the currents  $I_1, I_2$  induced in the small conducting square and in the big conducting rectangle, respectively. Each conducting loop has a resistance  $R = 9\Omega$

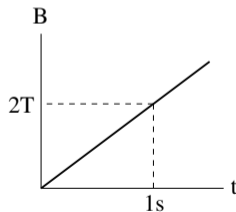
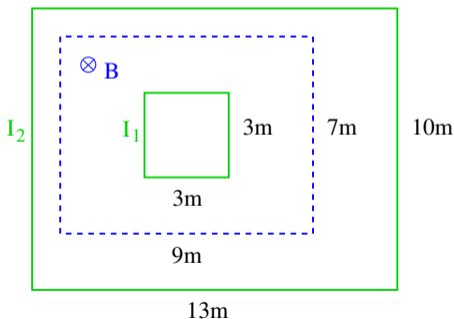



## Magnetic Induction: Application (4)



A magnetic field  $\vec{B}$  of increasing strength and directed perpendicular to the plane exists inside the dashed square. It induces a constant clockwise current  $I = 8\text{A}$  in the large conducting square with resistance  $R = 9\Omega$ .

- If  $\vec{B} = 0$  at time  $t = 0$ , find the direction ( $\odot, \otimes$ ) and magnitude of  $\vec{B}$  at time  $t = 5\text{s}$ .

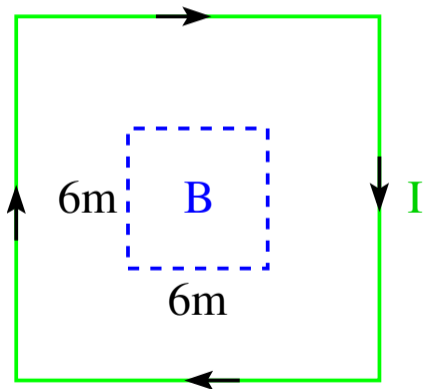

## Magnetic Induction: Application (13)



A rod of length  $\ell$ , mass  $m$ , and negligible resistance slides without friction down a pair of parallel conducting rails, which are connected at the top of the incline by a resistor with resistance  $R$ . A uniform vertical magnetic field  $\vec{B}$  exists throughout the region.

- Identify the forces acting on the rod when it slides down with velocity  $v$ .
- Determine the velocity for which all forces acting on the rod are in balance.

Determine the direction of the induced current from

- the magnetic force acting on the charge carriers in the rod,
- from the change in magnetic flux through the conducting loop,
- from Lenz's law.

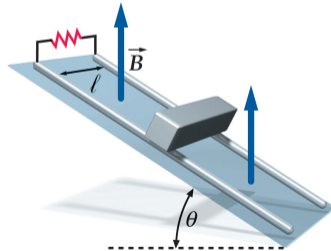

## Magnetic Induction: Application (5)



A uniform magnetic field  $\vec{B}$  pointing out of the plane exists inside the dashed square. Four conducting rectangles 1,2,3,4 move in the directions indicated.

- Find the direction (cw,ccw) of the current induced in each rectangle.

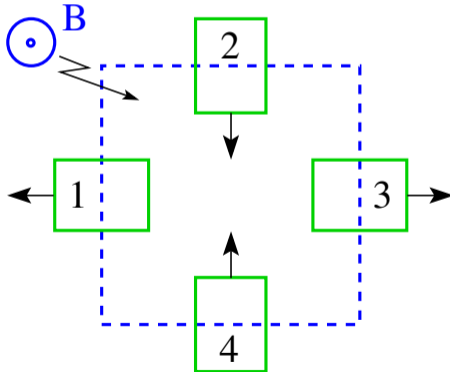



- Magnetic field  $\vec{B}$  (given)
- Surface  $S$  with perimeter loop (given)
- Surface area  $A$  (given)
- Area vector  $\vec{A} = A\hat{n}$  (my choice)
- Positive direction around perimeter: ccw (consequence of my choice)
- Magnetic flux:  $\Phi_B = \int \vec{B} \cdot d\vec{A} = \int \vec{B} \cdot \hat{n}dA$
- Consider situation with  $\frac{d\vec{B}}{dt} \neq 0$
- Induced electric field:  $\vec{E}$
- Induced EMF:  $\mathcal{E} = \oint \vec{E} \cdot d\vec{\ell}$   
(integral ccw around perimeter)
- Faraday's law:  $\mathcal{E} = -\frac{d\Phi_B}{dt}$

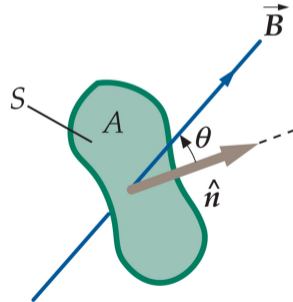



**The induced emf and induced current are in such a direction as to oppose the cause that produces them.**

- Lenz's rule is a statement of negative feedback.
- The cause is a change in magnetic flux through some loop.
- The loop can be real or fictitious.
- What opposes the cause is a magnetic field generated by the induced emf.
  - If the loop is a conductor the opposing magnetic field is generated by the induced current as stated in the law of Biot and Savart or in the restricted version of Ampère's law.
  - If the loop is not a conductor the opposing magnetic field is generated by the induced electric field as stated by the extended version of Ampère's law (to be discussed later).



In the situation shown below the current induced in the conducting ring generates a magnetic field whose flux counteracts the change in magnetic flux caused by the bar magnet.

- Moving the bar magnet closer to the ring increases the magnetic field  $\vec{B}_1$  (solid field lines) through the ring by the amount  $\Delta\vec{B}_1$ .
- The resultant change in magnetic flux through the ring induces a current  $I$  in the direction shown.
- The induced current  $I$ , in turn, generates a magnetic field  $\vec{B}_2$  (dashed field lines) in a direction that opposes the change of flux caused by the moving bar magnet.

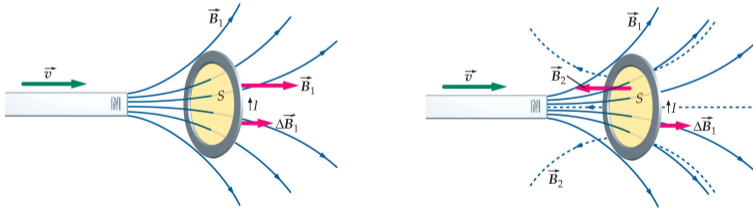

## Magnetic Induction: Application (9)



Consider a conducting rod of length  $L$  rotating with angular velocity  $\omega$  in a plane perpendicular to a uniform magnetic field  $\vec{B}$ .

- Angular velocity of slice:  $\omega$
- Linear velocity of slice:  $v = \omega r$
- EMF induced in slice:  $d\mathcal{E} = Bvdr$
- Slices are connected in series.
- EMF induced in rod:

$$\mathcal{E} = \int_0^L Bv dr = B\omega \int_0^L r dr$$

$$\Rightarrow \mathcal{E} = \frac{1}{2}B\omega L^2 = \frac{1}{2}Bv_0L, \quad v_0 = \omega L$$

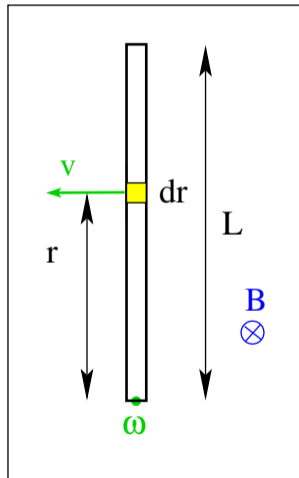

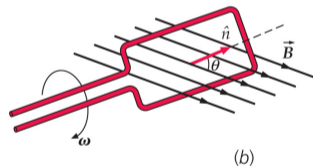
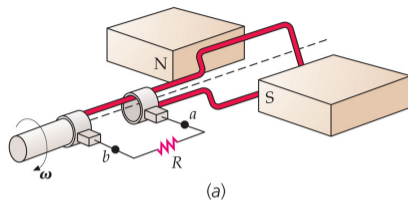

- Area of conducting loop:  $A$
- Number of loops:  $N$
- Area vector:  $\vec{A} = A\hat{n}$
- Magnetic field:  $\vec{B}$
- Angle between vectors  $\vec{A}$  and  $\vec{B}$ :  $\theta = \omega t$
- Magnetic flux:  $\Phi_B = N\vec{A} \cdot \vec{B} = NAB \cos(\omega t)$
- Induced EMF:  $\mathcal{E} = -\frac{d\Phi_B}{dt} = \underbrace{NAB\omega}_{\mathcal{E}_{max}} \sin(\omega t)$



## Intermediate Exam III: Problem #2 (Spring '06)



A conducting loop in the shape of a square with area  $A = 4\text{m}^2$  and resistance  $R = 5\Omega$  is placed in the  $yz$ -plane as shown. A time-dependent magnetic field  $\mathbf{B} = B_x\hat{\mathbf{i}}$  is present. The dependence of  $B_x$  on time is shown graphically.

- Find the magnetic flux  $\Phi_B$  through the loop at time  $t = 0$ .
- Find magnitude and direction (cw/ccw) of the induced current  $I$  at time  $t = 2\text{s}$ .

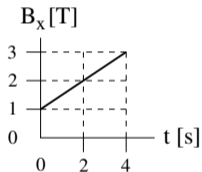
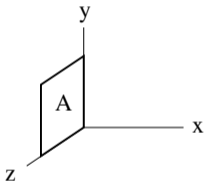

## Intermediate Exam III: Problem #2 (Spring '06)



A conducting loop in the shape of a square with area  $A = 4\text{m}^2$  and resistance  $R = 5\Omega$  is placed in the  $yz$ -plane as shown. A time-dependent magnetic field  $\mathbf{B} = B_x\hat{\mathbf{i}}$  is present. The dependence of  $B_x$  on time is shown graphically.

- (a) Find the magnetic flux  $\Phi_B$  through the loop at time  $t = 0$ .
- (b) Find magnitude and direction (cw/ccw) of the induced current  $I$  at time  $t = 2\text{s}$ .

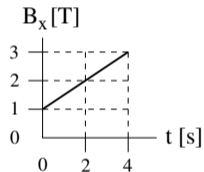
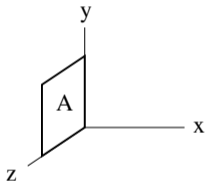

Choice of area vector:  $\odot/\otimes \Rightarrow$  positive direction = ccw/cw.

(a)  $\Phi_B = \pm(1\text{T})(4\text{m}^2) = \pm 4\text{Tm}^2$ .

## Intermediate Exam III: Problem #2 (Spring '06)



A conducting loop in the shape of a square with area  $A = 4\text{m}^2$  and resistance  $R = 5\Omega$  is placed in the  $yz$ -plane as shown. A time-dependent magnetic field  $\mathbf{B} = B_x\hat{\mathbf{i}}$  is present. The dependence of  $B_x$  on time is shown graphically.

- (a) Find the magnetic flux  $\Phi_B$  through the loop at time  $t = 0$ .
- (b) Find magnitude and direction (cw/ccw) of the induced current  $I$  at time  $t = 2\text{s}$ .

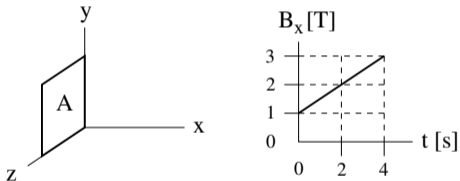

Choice of area vector:  $\odot/\otimes \Rightarrow$  positive direction = ccw/cw.

(a)  $\Phi_B = \pm(1\text{T})(4\text{m}^2) = \pm 4\text{Tm}^2$ .

(b)  $\frac{d\Phi_B}{dt} = \pm(0.5\text{T/s})(4\text{m}^2) = \pm 2\text{V} \quad \Rightarrow \quad \mathcal{E} = -\frac{d\Phi_B}{dt} = \mp 2\text{V}.$

$\Rightarrow I = \frac{\mathcal{E}}{R} = \mp \frac{2\text{V}}{5\Omega} = \mp 0.4\text{A} \quad (\text{cw}).$

## Intermediate Exam III: Problem #3 (Spring '07)



A conducting frame with a moving conducting rod is located in a uniform magnetic field as shown.

- Find the magnetic flux  $\Phi_B$  through the frame at the instant shown.
- Find the induced emf  $\mathcal{E}$  at the instant shown.
- Find the direction (cw/ccw) of the induced current.

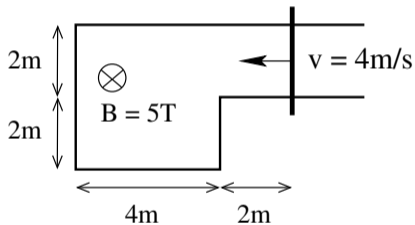

## Intermediate Exam III: Problem #3 (Spring '07)



A conducting frame with a moving conducting rod is located in a uniform magnetic field as shown.

- Find the magnetic flux  $\Phi_B$  through the frame at the instant shown.
- Find the induced emf  $\mathcal{E}$  at the instant shown.
- Find the direction (cw/ccw) of the induced current.

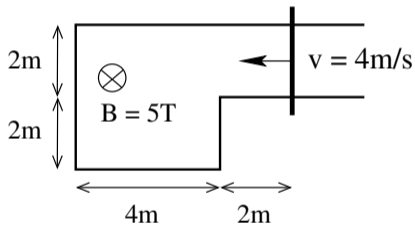

**Solution:**

$$(a) \Phi_B = \vec{A} \cdot \vec{B} = \pm(20\text{m}^2)(5\text{T}) = \pm 100\text{Wb}.$$



A conducting frame with a moving conducting rod is located in a uniform magnetic field as shown.

- Find the magnetic flux  $\Phi_B$  through the frame at the instant shown.
- Find the induced emf  $\mathcal{E}$  at the instant shown.
- Find the direction (cw/ccw) of the induced current.

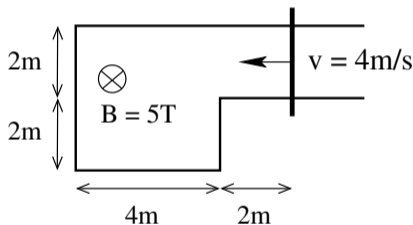

**Solution:**

$$(a) \Phi_B = \vec{A} \cdot \vec{B} = \pm(20\text{m}^2)(5\text{T}) = \pm 100\text{Wb}.$$

$$(b) \mathcal{E} = -\frac{d\Phi_B}{dt} = \pm(5\text{T})(2\text{m})(4\text{m/s}) = \pm 40\text{V}.$$

## Intermediate Exam III: Problem #3 (Spring '07)



A conducting frame with a moving conducting rod is located in a uniform magnetic field as shown.

(a) Find the magnetic flux  $\Phi_B$  through the frame at the instant shown.

(b) Find the induced emf  $\mathcal{E}$  at the instant shown.

(c) Find the direction (cw/ccw) of the induced current.

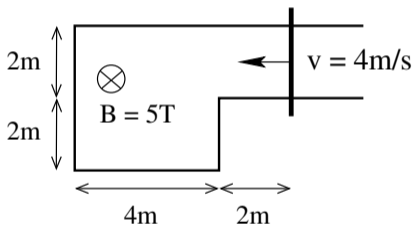

**Solution:**

(a)  $\Phi_B = \vec{A} \cdot \vec{B} = \pm(20\text{m}^2)(5\text{T}) = \pm 100\text{Wb}.$

(b)  $\mathcal{E} = -\frac{d\Phi_B}{dt} = \pm(5\text{T})(2\text{m})(4\text{m/s}) = \pm 40\text{V}.$

(c) clockwise.

## Unit Exam III: Problem #3 (Spring '09)



A pair of rails are connected by two mobile rods. A uniform magnetic field  $B$  directed into the plane is present. In the situations (a), (b), (c), (d), one or both rods move at constant velocity as shown. The resistance of the conducting loop is  $R = 0.2\Omega$  in each case. Find magnitude  $I$  and direction (cw/ccw) of the induced current in each case.

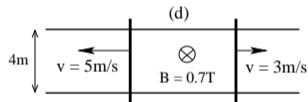
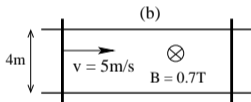
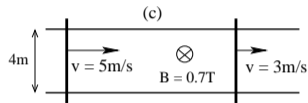
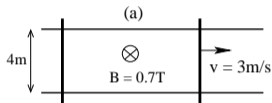





A pair of rails are connected by two mobile rods. A uniform magnetic field  $B$  directed into the plane is present. In the situations (a), (b), (c), (d), one or both rods move at constant velocity as shown. The resistance of the conducting loop is  $R = 0.2\Omega$  in each case. Find magnitude  $I$  and direction (cw/ccw) of the induced current in each case.

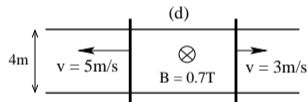
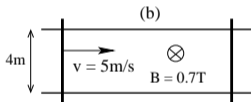
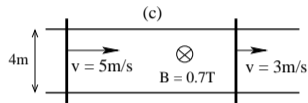
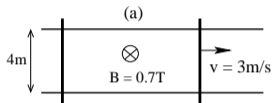

**Solution:**

$$(a) \quad |\mathcal{E}| = (3\text{m/s})(0.7\text{T})(4\text{m}) = 8.4\text{V}, \quad I = \frac{8.4\text{V}}{0.2\Omega} = 42\text{A} \quad \text{ccw}$$



A pair of rails are connected by two mobile rods. A uniform magnetic field  $B$  directed into the plane is present. In the situations (a), (b), (c), (d), one or both rods move at constant velocity as shown. The resistance of the conducting loop is  $R = 0.2\Omega$  in each case. Find magnitude  $I$  and direction (cw/ccw) of the induced current in each case.

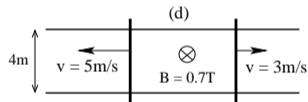
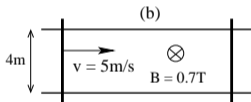
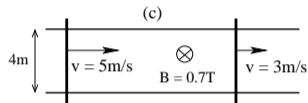
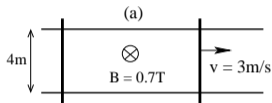

**Solution:**

$$(a) \quad |\mathcal{E}| = (3\text{m/s})(0.7\text{T})(4\text{m}) = 8.4\text{V}, \quad I = \frac{8.4\text{V}}{0.2\Omega} = 42\text{A} \quad \text{ccw}$$

$$(b) \quad |\mathcal{E}| = (5\text{m/s})(0.7\text{T})(4\text{m}) = 14\text{V}, \quad I = \frac{14\text{V}}{0.2\Omega} = 70\text{A} \quad \text{cw}$$

## Unit Exam III: Problem #3 (Spring '09)



A pair of rails are connected by two mobile rods. A uniform magnetic field  $B$  directed into the plane is present. In the situations (a), (b), (c), (d), one or both rods move at constant velocity as shown. The resistance of the conducting loop is  $R = 0.2\Omega$  in each case. Find magnitude  $I$  and direction (cw/ccw) of the induced current in each case.

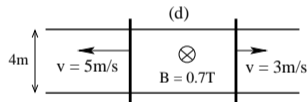
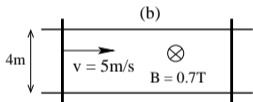
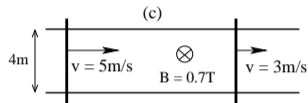
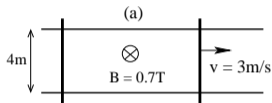

**Solution:**

$$(a) |\mathcal{E}| = (3\text{m/s})(0.7\text{T})(4\text{m}) = 8.4\text{V}, \quad I = \frac{8.4\text{V}}{0.2\Omega} = 42\text{A} \quad \text{ccw}$$

$$(b) |\mathcal{E}| = (5\text{m/s})(0.7\text{T})(4\text{m}) = 14\text{V}, \quad I = \frac{14\text{V}}{0.2\Omega} = 70\text{A} \quad \text{cw}$$

$$(c) |\mathcal{E}| = (5\text{m/s} - 3\text{m/s})(0.7\text{T})(4\text{m}) = 5.6\text{V}, \quad I = \frac{5.6\text{V}}{0.2\Omega} = 28\text{A} \quad \text{cw}$$

## Unit Exam III: Problem #3 (Spring '09)



A pair of rails are connected by two mobile rods. A uniform magnetic field  $B$  directed into the plane is present. In the situations (a), (b), (c), (d), one or both rods move at constant velocity as shown. The resistance of the conducting loop is  $R = 0.2\Omega$  in each case. Find magnitude  $I$  and direction (cw/ccw) of the induced current in each case.

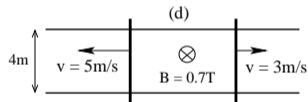
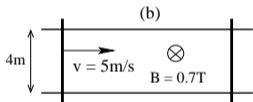
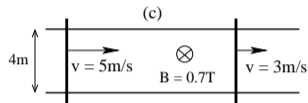
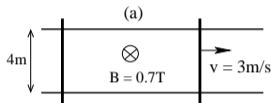

**Solution:**

$$(a) |\mathcal{E}| = (3\text{m/s})(0.7\text{T})(4\text{m}) = 8.4\text{V}, \quad I = \frac{8.4\text{V}}{0.2\Omega} = 42\text{A} \quad \text{ccw}$$

$$(b) |\mathcal{E}| = (5\text{m/s})(0.7\text{T})(4\text{m}) = 14\text{V}, \quad I = \frac{14\text{V}}{0.2\Omega} = 70\text{A} \quad \text{cw}$$

$$(c) |\mathcal{E}| = (5\text{m/s} - 3\text{m/s})(0.7\text{T})(4\text{m}) = 5.6\text{V}, \quad I = \frac{5.6\text{V}}{0.2\Omega} = 28\text{A} \quad \text{cw}$$

$$(d) |\mathcal{E}| = (5\text{m/s} + 3\text{m/s})(0.7\text{T})(4\text{m}) = 22.4\text{V}, \quad I = \frac{22.4\text{V}}{0.2\Omega} = 112\text{A} \quad \text{ccw}$$

## Magnetic Induction: Application (14)



Consider a conducting frame moving in the magnetic field of a straight current-carrying wire.

- magnetic field:  $B = \frac{\mu_0 I}{2\pi r}$
- magnetic flux:  $\Phi_B = \int \vec{B} \cdot \vec{A}, \quad dA = adr$

$$\Phi_B = \frac{\mu_0 I a}{2\pi} \int_x^{x+b} \frac{dr}{r} = \frac{\mu_0 I a}{2\pi} [\ln(x+b) - \ln x] = \frac{\mu_0 I a}{2\pi} \ln \frac{x+b}{x}$$

- induced EMF:  $\mathcal{E} = -\frac{d\Phi_B}{dt} = -\frac{d\Phi_B}{dx} \frac{dx}{dt} = -\frac{d\Phi_B}{dx} v$

$$\mathcal{E} = -\frac{\mu_0 I a v}{2\pi} \left[ \frac{1}{x+b} - \frac{1}{x} \right] = \frac{\mu_0 I a b v}{2\pi x(x+b)}$$

- induced current:  $I_{ind} = \frac{\mathcal{E}}{R}$  clockwise

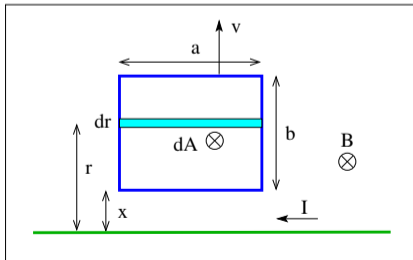

## Magnetic Induction: Application (8)



Consider a rectangular loop of width  $\ell$  in a uniform magnetic field  $\vec{B}$  directed into the plane. A slide wire of mass  $m$  is given an initial velocity  $\vec{v}_0$  to the right. There is no friction between the slide wire and the loop. The resistance  $R$  of the loop is constant.

- Find the magnetic force on the slide wire as a function of its velocity.
- Find the velocity of the slide wire as a function of time.
- Find the total distance traveled by the slide wire.

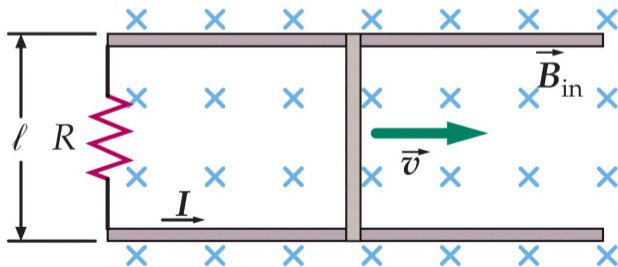

# Magnetic Induction: Application (1)



Consider three metal rods of length  $L = 2\text{m}$  moving translationally or rotationally across a uniform magnetic field  $B = 1\text{T}$  directed into the plane.

All velocity vectors have magnitude  $v = 2\text{m/s}$ .

- Find the induced EMF  $\mathcal{E}$  between the ends of each rod.

